

The Science of Timekeeping

Application Note 1289

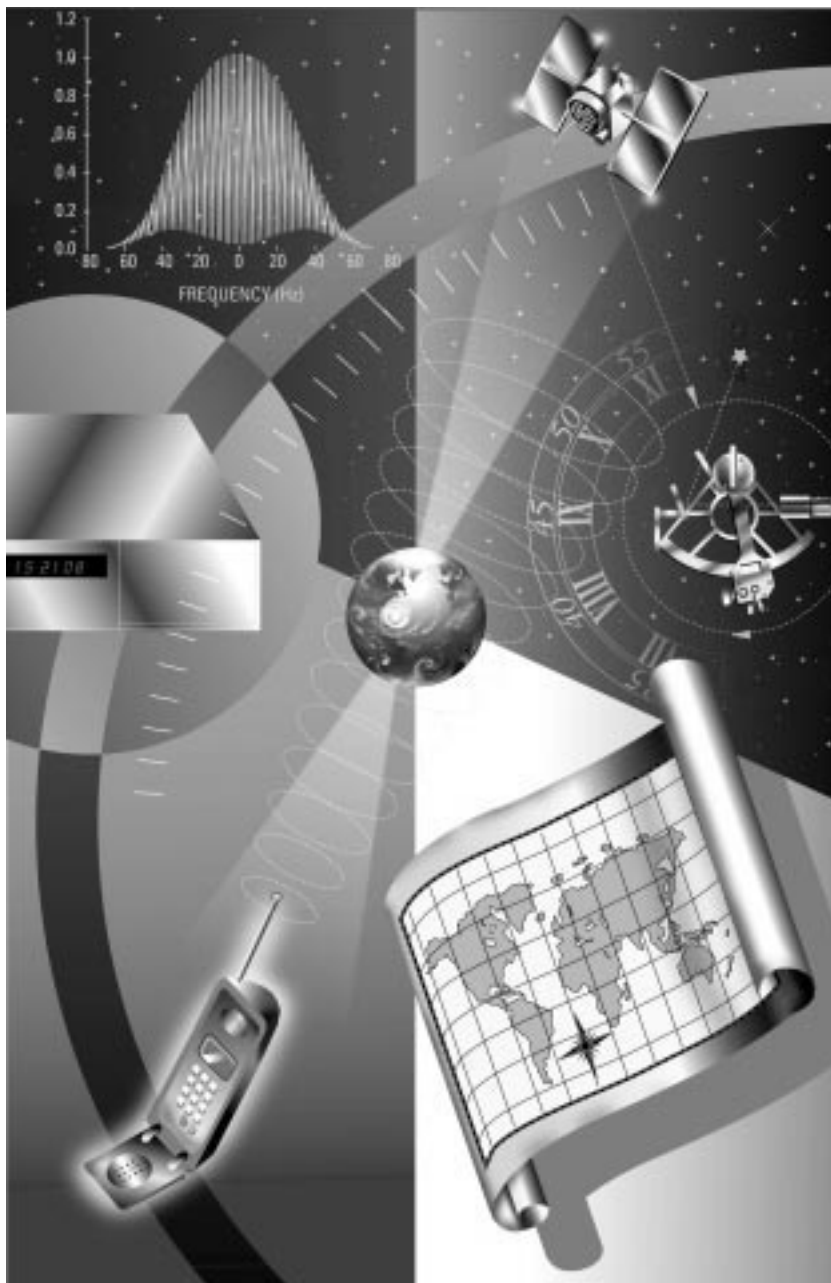

-
- **UTC: Official World Time**
 - **GPS: A Time Distribution Utility**
 - **Time: An Historical and Future Perspective**
 - **From Laboratory to Practical Use**
 - **Broad Applications Across Society**

Table of Contents

Introduction to the Science of Timekeeping	8
Precise Timing Applications Pervade Our Society	10
Clocks and Timekeeping.....	14
The Definition of the Second and its General Importance	19
Historical Perspective	19
An Illustrative Timekeeping Example	22
UTC, Official Time for the World	26
GPS Time and UTC	30
Accuracy and Stability of UTC.....	31
Einstein's Relativity and Precise Timekeeping	36
How to Access UTC	39
Future Timing Techniques.....	44
Global Navigation Satellite System Developments.....	47
UTC and the Future	52
Conclusions	53
Acknowledgments	54
Appendix A: Time and Frequency Measures Accuracy, Error, Precision, Predictability, Stability, and Uncertainty	56
Appendix B: Stability Analysis of Harrison-like Chronometers	66
Appendix C: Time and Frequency Transfer, Distribution and Dissemination Systems.....	72
Glossary and Definitions.....	82
Bibliography	85

Hewlett-Packard is grateful to the three authors of this application note for sharing their expertise. Their combined knowledge offers a resource which will undoubtedly be considered a classic reference on the science of timekeeping for decades to come.

David W. Allan

David W. Allan was born in Mapleton, Utah on September 25, 1936. He received the B.S. and M.S. degrees in physics from Brigham Young University, Provo, Utah and from the University of Colorado, respectively. From 1960 until 1992 he worked at the U.S. National Institute of Standards and Technology (NIST), formerly the National Bureau of Standards (NBS). His work with time and frequency research, development and generation has been with colleagues throughout the U.S. as well as in many other countries. In cooperation with several colleagues, his principal contributions have been: 1) development of internationally adopted methods of characterizing the performance of clocks, oscillators and time and frequency distribution systems — known as the Allan variance, the Modified Allan variance and the Time variance; 2) development of a time-scale algorithm technique which combines clock readings for optimum and robust performance of the output — being better than the best clock in the ensemble and which has been used for more than 28 years to generate official time from NBS/NIST; 3) development of the dual-mixer time difference technique, which allows clock measurements at the sub-picosecond level; 4) development of the GPS common-view time transfer technique, which is used to transfer clock times from around the world to the International Bureau of Weights and Measures for the generation of International Atomic Time and UTC, and for the comparison of the frequencies of the best primary standards in the world, and which provides a major benefit to the timing for NASA Jet Propulsion Laboratory's (JPL's) Deep Space tracking Network; 5) development of improved timing in support of the measurements of millisecond pulsars and the discovery, in this regard, of a random-walk effect of the total electron content in the galactic interstellar medium; 6) the development of a method of separating out the various error components causing inaccuracies in the Global Positioning System (GPS) performance; 7) the measurement of the relativistic Sagnac effect for the rotating Earth using GPS to transport time around the world; and 8) the invention of techniques (algorithms and measurement procedures) which allow a clock or set of clocks to always be correct; a patent associated therewith was later licensed by Hewlett-Packard and formed the basis of the HP SmartClock technology.

Since retiring from NIST, Dave has developed a method of defeating the degradation (Selective Availability) on the GPS for timing purposes. Most recently, he led an R&D effort which has the potential of real-time satellite orbit determination at the centimeter level.

He has published well over a hundred papers, has contributed chapters in several books, chaired several international timing committees, organized several tutorials and seminars, and participated on several other committees — including being the U.S. representative from NBS/NIST for two decades on the international Consultative Committee for the Definition of the Second. His greatest satisfaction is that his work is used and referenced often — hopefully for the benefit of a better world.



David W. Allan

Neil Ashby

Neil Ashby was born in Dalhart, Texas on March 5, 1934. He received the B.A. degree (Summa Cum Laude) in physics from the University of Colorado, Boulder, in 1955, and the M.S. and Ph.D. degrees from Harvard University, Cambridge, Massachusetts in 1956 and 1961, respectively. After spending a year in Europe as a postdoctoral fellow, he joined the faculty of the Department of Physics at the University of Colorado in 1962. He has been a Professor of Physics there since 1970, and was Department Chair from 1984–1988. He consults for the Time and Frequency Division of the National Institute of Standards and Technology, working on relativistic effects on clocks and global time synchronization. His work was the basis of general relativistic correction being properly included in the Global Positioning System. He has been a member of the International Committee on General Relativity and Gravitation from 1989–1995. He serves on several international working groups on relativistic effects in geodesy and in metrology.



Neil Ashby

Clifford C. Hodge

Cliff Hodge received the B.Sc. degree with First Class Honours in Physics from the Imperial College of Science, Technology and Medicine in South Kensington, London, in 1985. He continued his studies at Imperial College by joining the newly-formed Semiconductor Physics Group. In 1990, he was awarded the Ph.D. degree for his work on “Induced absorption of novel semiconductor superlattices” for optical and magneto-optical studies on a range of narrow- (indium arsenide-based) and wide- (gallium arsenide-based) band gap materials. In 1990, Cliff worked at the NASA Jet Propulsion Laboratory in Pasadena, California, as a Resident Research Associate in the Atmospheric and Oceanographic Sciences Division developing high-frequency modulation techniques using lead-salt semiconductor lasers for the observation in real-time of a range of gaseous species in the stratosphere, as part of the Airborne Arctic Stratospheric Expedition (AASE II) Programme. In 1992, he joined the National Physical Laboratory (NPL) in Teddington, Middlesex, as Project Leader developing a cryogenic all-sapphire Super Mirror resonator for the intercomparison of the Allan variance of frequency standards in the microwave and optical region of the electromagnetic spectrum. Dr. Hodge has recently advised the European Space Research and Technology Centre (ESTEC) on “stable clocks and time-transfer techniques for GNSS2” as part of the Thomson-CSF-led Consortium. In March 1996, he organized an ESTEC-sponsored GNSS2 Workshop at NPL which brought together the Time and Frequency specialists with the GNSS experts to a one-day Workshop entitled: “Next-Generation GNSS and The Frontiers of Time and Frequency Measurement.” Cliff remains actively involved in the exciting developments throughout Europe, the United States, the Russian Federation and Asia, towards a seamless international Global Navigation Satellite System (GNSS).

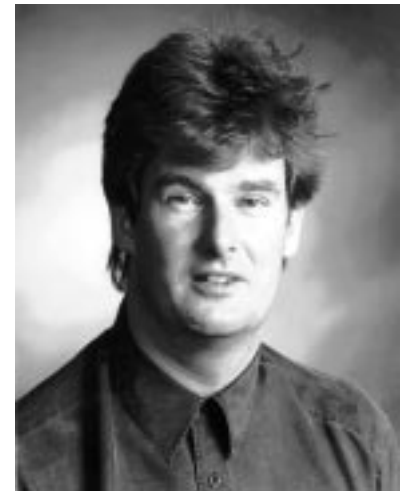

Cliff Hodge

Cliff’s interest in promoting the new science and novel applications that could be reaped from the latest improvements in accurate clocks and two-way time-transfer techniques has continued with the recent submission of a collaborative proposal to the ESA for an Atomic Clock Ensemble in Space (ACES) on board the International Space Stations ALPHA (ISSA).

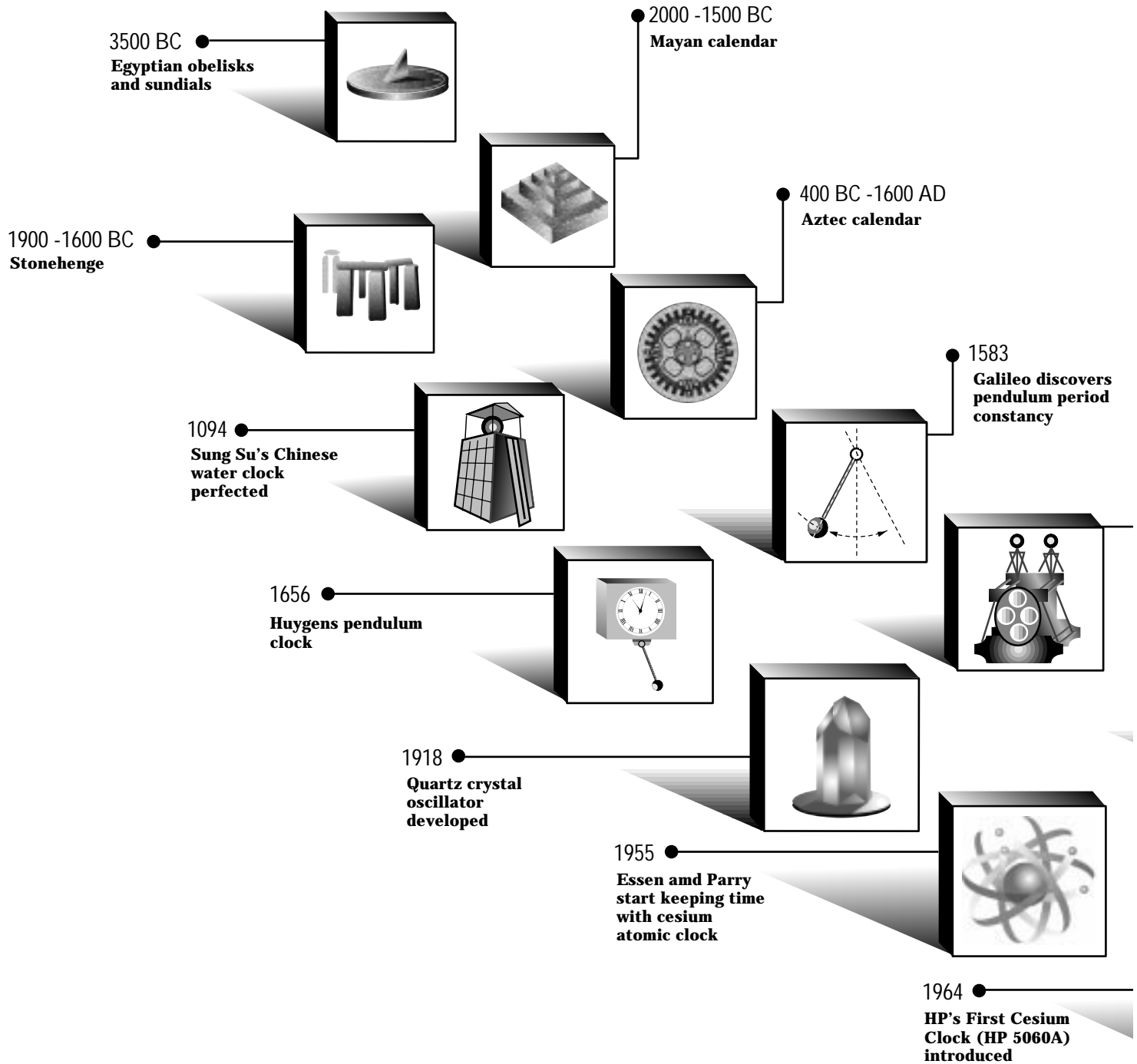

Milestones in the Progress of Timekeeping

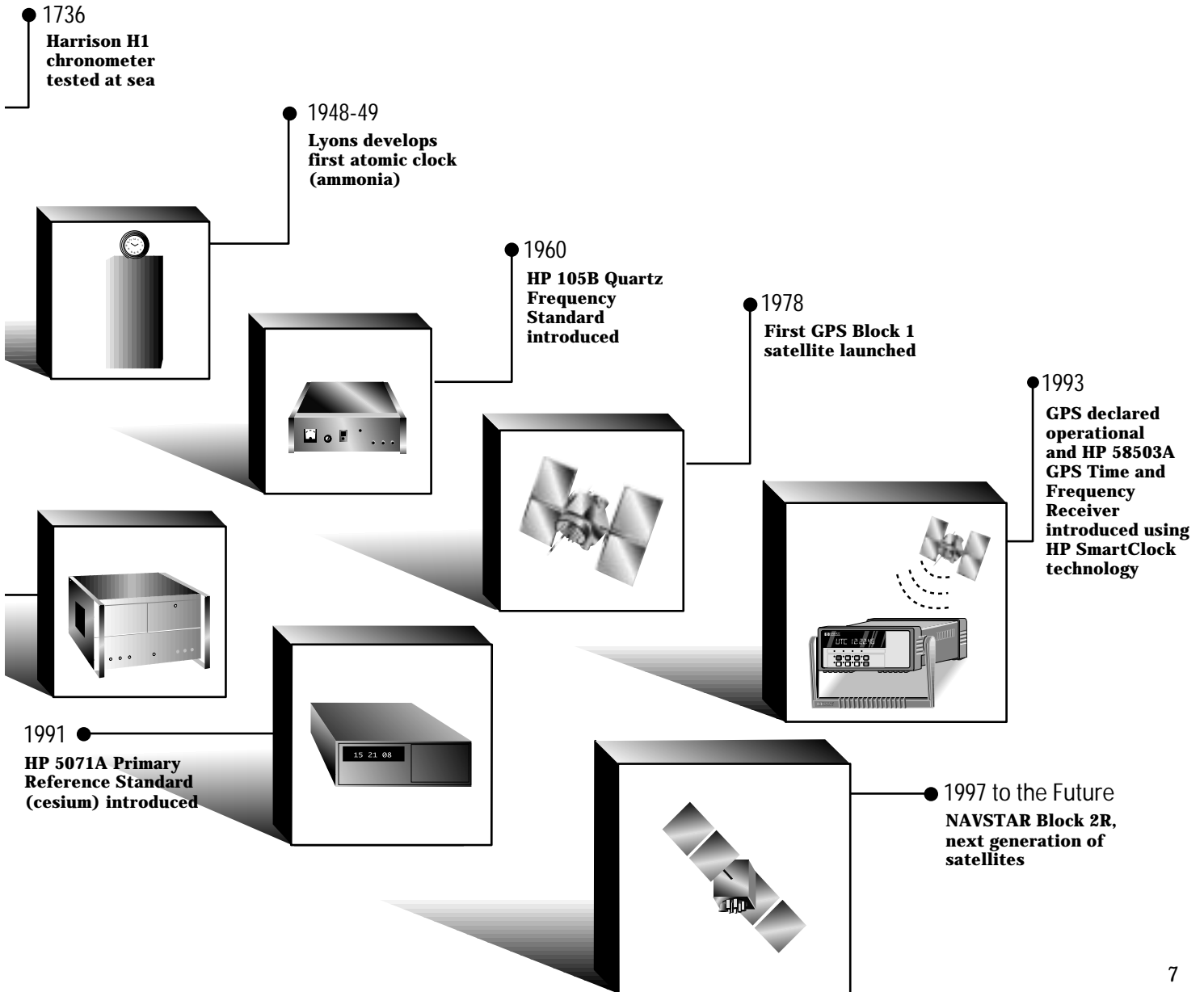

Introduction to the Science of Timekeeping

There is no such thing as a singular true time derived from natural phenomena. Yet we live in a world in which time is nearly as important — and taken for granted — as the cycles of nature. “What time is it?” is a question asked almost as automatically as taking a breath. Far more seldom the question is asked, “What is time?” Depending on the circumstances, a degree of accuracy is sought when we ask for the time. A remote farmer might gauge the setting sun to determine the approach of dinnertime. Most people glance at their watch or a nearby clock to calibrate their day’s activities. Though few individuals are involved in the process of consulting the accuracy of atomic clocks, the impact of their accuracy is so far-reaching in society that virtually everyone benefits thereby. Nevertheless, no watch or clock is completely accurate. Each has its own errors due to rate imperfections and errors in setting. Your watch will display a time that is different from the time displayed on any other watch, so you can never really know precisely what time it is. The correct time is simply based on an agreed standard. Currently, Universal Time Coordinated (UTC) has been established as the world time scale.

In the 15th century, explorers took to the high seas in search of new worlds and exotic treasures. To navigate, seafarers could determine their latitude by using a sextant to observe the position of the sun at midday or bright stars at night. Unfortunately, determining longitude was more difficult. Because the earth rotates, measuring longitude requires both a sextant and an accurate clock. In the 15th and 16th centuries, clocks were insufficiently accurate to navigate with any certainty, and this all too often led to disaster.

Visibility of this burning maritime issue was heightened in 1707 when Admiral Sir Cloudesly Shovell miscalculated his position and wrecked his flagship and 3 other British warships off the Scillies, losing nearly 2,000 lives, including his own. Even though his main error was in latitude estimation — exacerbated by the persistent fog so that he could see neither night sky or daytime sun — longitude continued to be, generally, the biggest source of error. In 1714 Sir Isaac Newton explained “for determining the Longitude at sea, there have been several projects, true in theory, but difficult to execute...one is by watch,...but by reason of the motion of the ship,...variation of heat and cold...such a watch hath not yet been made.”

Spurred to action, the British government established an official body, The Board of Longitude, in 1714. The board offered the longitude prize (£20,000 or about \$2,000,000 US today) to the person who could contrive a means of resolving position at sea to within 30 nautical miles after sailing to the West Indies. This required a clock that could keep time to within 3 seconds per day.

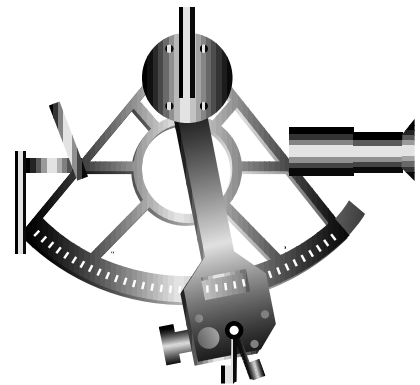

For half a century, all manner of charlatans and pseudo-scientific crackpots tried to claim the prize, but none could solve the fundamental scientific problem of determining longitude at sea. During this time, John Harrison (1693–1776), a woodworker and musician from Lincolnshire, devoted his life and genius to solving the problem. Through intuition and sheer effort he developed a clock, a maritime chronometer, that kept time accurate to one second per day. Harrison's chronometer was a great advance for maritime navigation — overcoming the harsh environmental conditions encountered at sea. Using a copy of Harrison's clock, Captain James Cook mapped the Polynesian islands and the Pacific Ocean regions. He wrote in his log book great praise for the new navigational instrument, “our trusty friend the watch” and “our never failing guide.”

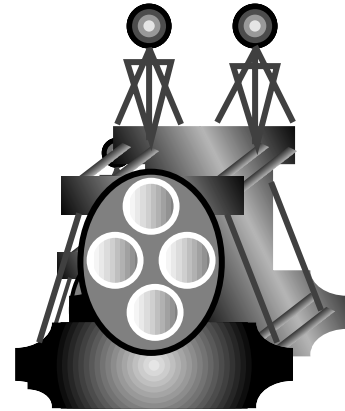

Having timepieces with good long-term accuracy, navigators now needed to synchronize their chronometers to a central clock. In Britain, ships would sail up the Thames and watch a ball drop from a tower at the Greenwich observatory at precisely 1:00 pm. Other nations with large navies and merchant fleets, such as Portugal and France, had their own standard time and debate raged over which meridian should be used for standard time. In 1884, at the International Meridian Conference, the Greenwich observatory was accepted as source of the world's standard time. Thus was coined Greenwich Mean Time or GMT, a standard that dominated world timekeeping for nearly a century.

Over time, clocks have improved dramatically and needs have changed, so GMT has evolved to UTC. The acronym UTC is an English-French mixture for Coordinated Universal Time (Temps Universel Coordonné in French). Following International Telecommunications Union Recommendation TF.536 on Time-Scale Notations, it was internationally agreed to write Universal Coordinated Time as UTC, rather than CUT or TUC, making it language-independent. GMT was based on mean solar time. UTC is based on a definition of the second that is nearly a million times more accurate. Under the general umbrella of *la Convention du Mètre*, this new second is based on a quantum resonance within a cesium atom.

In contrast, GMT was astronomically based and had a physical clock at the Greenwich Observatory where they used to drop the ball at the defined time. No physical clock keeps UTC. UTC is established by the Bureau International des Poids et Mesures (BIPM) based on an aggregate of data from timing laboratories throughout the world, and from input from the International Earth Rotation Service (IERS). In a world of ever-increasing precise-timing needs, not to have a single reference clock seems paradoxical. Fortunately, for everyday purposes, clocks are sufficiently accurate to meet most needs.

Precise Timing Applications Pervade Our Society

The number and variety of applications using precise timing are astounding and increasing. Currently, the count of precise timing components manufactured and marketed each year is in the billions. The world has evolved into the information age, and precise timing is at the heart of managing the flow of that information so that it is reliable, robust and inexpensive. Thus, all of mankind may use it efficiently and effectively.

Practical, precise timing came with the invention of the quartz-crystal oscillator and quartz-crystal filters, which are essential elements for radio, radar and television with their enormous, far-reaching impact on our society. Information is literally flowing at the speed of light in computers and communications systems. With their ever-increasing capabilities, they wouldn't work without precise timing of gates and network nodes. The arrival of atomic clocks provided even more accuracy and opened new vistas. Unprecedented navigation is now literally at our fingertips using relatively inexpensive hand-held GPS receivers; yet the heart of GPS is an atomic-clock synchronized system.

Since their invention, the accuracy of atomic clocks has improved, on the average, by a factor of two every two years. It is interesting that this geometric progression rate of improvement is the same for computer memory density. Moving from the laboratory to the workplace, the cost of precision clocks has dropped phenomenally, as has the size of these devices. Now, a computer with memory, its precision timing circuitry, and even a transmitter can be made so tiny that a single chip containing all of them can be inserted under the skin of an animal for monitoring and control.

The most accurate measurement known to humanity is the measurement of the duration of the second. The peak of the pyramid for accurate time and frequency is the international reference, UTC. The current best accuracy for the determination of the second results in a time error of ± 0.3 nanoseconds (billionths of a second) per day. This is equivalent to ± 1 second in 10 million years.

Because time and frequency can be measured so accurately, time and frequency devices are often used to measure other fundamental quantities, such as the volt, the ampere, the ohm, and the meter. For example, the General Conference of Weights and Measures (CGPM, Conférence Générale des Poids et Mesures) redefined the meter as "the length of the path travelled by light in vacuum during a time interval of $1/299\,792\,458$ of a second (17th CGPM, 1983, Resolution 1)." It is expected that eventually, all base units in metrology for the support of technological development will be traceable back to the second. Even now, science and technology are taking more and more advantage of the ease and accuracy with which time and frequency can be generated, disseminated, and utilized.

The Global Positioning System (GPS) is a classic example of using precise timing for accurate positioning. Many navigation systems predating GPS also use atomic clocks, but they are ground-based. GPS features a set of 24 orbiting satellites, each with a synchronized atomic clock on board. It effectively puts a super-accurate clock in the sky for everyone to see with the eyes of modern technology. At any given time and at any point on Earth, at least four of these satellites can be seen. A precise timing device in a GPS receiver is used by its computer to calculate the time of flight of the signal from each of the observable satellites. Since the signals travel at the velocity of light, and this is known exactly, the receiver's computer can turn the time of flight into a very accurate estimate of the distance to each satellite — accounting for some delays in both the neutral and ionized parts of the atmosphere. GPS satellites also broadcast their positions. Information received from four satellites yields four equations which can be solved for four unknowns: latitude, longitude, altitude, and GPS-system time. In this process, the high accuracy of the GPS atomic clocks is transferred to the precision quartz-crystal clock inside the receiver. Therefore, high accuracy position and time are readily available (from which velocity can be deduced), and a multitude of users are capitalizing on this. GPS is like a free utility with application opportunities limited only by our imaginations. As a result, the number of users, and the variety of uses of GPS have literally exploded.

Location via GPS is becoming very popular for consumer applications. Cars are already available equipped to provide navigational and directional information. Some cars even use GPS to enhance security and mayday systems. Several GPS and time-based location systems are currently being developed to provide precise location of cellular phones for applications such as emergency response, location-sensitive billing, and fraud detection. Hikers and boaters have long enjoyed the benefits of GPS navigation and a GPS receiver is now being made for the golfing enthusiast to measure the distance to the pin!

To understand the pervasiveness of GPS, consider a recent receiver survey by *GPS World* magazine which lists over 300 different kinds of receivers available from 50 companies. In addition, massive systems are now being developed that largely depend on GPS. For example, most countries are now planning to use GPS with augmentation from other systems for navigation and control of all aircraft. In 1996, well over half a million GPS receivers were marketed by Japan, alone, for determining the position of ground vehicles.

Even though GPS is predominantly a navigation system, the navigation accuracy is dependent on precise timing techniques. Precise timing is also embedded as part of the technology in a long list of other GPS applications. The following list of applications is not intended to be detailed, is far from exhaustive, and continues to expand: aerial photogrammetry, astrometry, astronomy, atmospheric studies and measurements (ionosphere and troposphere), attitude determination, aviation, calibrating other instruments, communications, differential GPS, dredging, earthquake monitoring and prediction, exploration, frequency

comparison of world standards for the second, geodesy, geodynamics and Earth-plate tectonics, geographic information systems, hydrography, mapping, military, mineral exploration and mining, NASA Jet Propulsion Laboratory's Deep Space Network, navigation (air, land, marine), oceanography, offshore oil exploration, position determination, precision farming, positive train control, recreational (for example, hiking and orienteering), resource management, search and rescue, spacecraft guidance, surveying, timing, tracking (vehicular and nonvehicular), traffic management, and weather measurements and prediction. *GPS World* magazine kindly helped generate this list.

There are a variety of novel applications using GPS — some of great scientific interest. In 1982, the first millisecond pulsar was discovered using the Arecibo Observatory radio telescope in Puerto Rico. The arriving pulse stream, which left the star some 13 thousand years ago, was exceedingly uniform with only 1.55780645169838 milliseconds between the pulses. It challenges the mind to think of a neutron star with about the same mass as our sun, with a radius of only about 10 km, spinning 642 revolutions per second and radiating an enormous pulse of electromagnetic energy with each rotation. Listening to this signal at the Arecibo Observatory is like listening to the musical note E above middle C on the musical scale. Several observatories around the world have teamed up to study these unusual celestial objects — of which there are now more than 30 known. GPS is the principal time and frequency transfer standard for the measurement of these incredibly uniform timing pulses. Using GPS these signals are compared with the best atomic clocks in the world. Some of these millisecond pulsar timing signals have stabilities that approach the best of atomic clocks [1, 2]. Current time-predictability uncertainty estimates are on the order of a second in well over a million years. Having a very stable galactic-pulsar clock, external to our solar system and about 13 thousand light years away, has provided a great deal of information about our interstellar medium, our orbit around the sun, and the coordinate reference frame for astrometry. Along with other things, scientists are trying to use these ultra-precise measurements to detect gravitational waves which give rise to distortion of space and time, as were predicted by Einstein in the early part of the century.

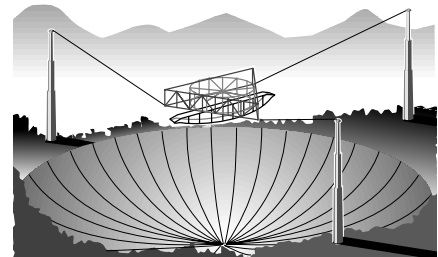

Usually, the largest body of users of precise and accurate timing techniques is thought to be within the areas of navigation (including position determination) and communication systems (including radio, TV, video, multimedia, telephone, cellular, internet, etc.). And though this is probably true, the trends in society show rapidly developing and interesting applications. Optical barcoding and barcode scanners are permeating the market place; scanners now number in the millions. The technique uses lasers and timing signals to read the code. Laser is an acronym for “Light Amplification by Stimulated Emission of Radiation.” Lasers evolved out of the work with masers, where the “m” in maser stands for microwave. Both are used extensively in time and frequency metrology because they provide a unique degree of frequency stability in their emission. Lasers are directly amenable to

barcode scanning because all of the emitted photons are in step — providing a high-intensity and highly directed beam of light. The laser's high intensity spot of light bounces off the light and dark spaces of the barcode. The timing of intensity changes of the reflected light allows the decoding of four different widths of bars and more than 50 bits of information in the blink of an eye. While the precise frequency and timing requirements for this application are very relaxed, the laser principle makes it work. In the United States, mail handling has been facilitated greatly with the use of optical barcode scanners. Lasers are also at the heart of the success of the popular laser printer and are used extensively in copiers as well. CD-ROMs and CD music disks are read with lasers at megahertz rates, and now laser dental drills can repair cavities pain-free.

In the general body of precise time and frequency users, telecommunication and navigation systems require very high levels of precise network synchronization. The electric power grid uses precise timing for efficient power flow and for fault detection. These systems have moved from milliseconds, to microseconds, to nanoseconds in their timing requirements. Optical fiber transmissions are now working at the sub-nanosecond level. Magnetic Resonance Imaging (MRI) is a direct spinoff utilizing precision frequency spectroscopy techniques. New MRI techniques now being developed will provide fine-detailed, non-invasive scans of the brain [3]. Transportation system problems are being solved by turning to precise timing techniques. The technology exists today with the potential for determining the position of a vehicle to about a centimeter using precise and accurate time and frequency techniques. Computer networks require precise timing. The banking and business industries are increasingly using precise timing to time-tag transactions. New cars and appliances extensively use microprocessors and quartz-crystal oscillators and filters. The automobile of the future will have its position and course displayed on the dashboard.

Several Nobel laureates have contributed in fundamental ways to the success of time and frequency techniques. It would be nearly impossible to list all the ways that precise time and frequency tools have benefitted humanity. These tools and techniques are often in the background silently serving society's needs. The increasing communication and mobility capabilities promise to foster understanding among the nations and cultures of the world.

Clocks and Timekeeping

Almost any clock may be considered a two-part device (see Figure 1). First, a clock will have an oscillating device for determining the length of the *second* or some other desired time interval. This is usually referred to as the clock's frequency standard, which oscillates at some rate determined by the laws of physics. Historically, the pendulum was the classic source of time interval. Currently, the typical wristwatch has as its frequency standard a quartz-crystal tuning fork with an oscillation frequency of 32,768 Hz (one Hertz, abbreviated Hz, is a cycle per second). This number of oscillations is convenient for the associated digital electronic circuit, because if this number is divided by 2^{15} , which is easy for a digital chip divider, the result is one cycle or pulse per second.

In simple terms, atomic clocks generally provide a much more accurate frequency than can be generated by any physical device such as a pendulum or quartz crystal oscillator. An atomic clock uses as its reference the oscillation of an electromagnetic signal associated with a quantum transition between two energy levels in an atom. This bundle of electromagnetic energy is called a photon and its energy, E , is equal to the difference in energy between these two levels. The photon may be either given off or absorbed by the atom.

For a given quantum transition, the photons emitted or absorbed have a unique frequency proportional to the energy difference with little variability around this value. The relationship between this energy difference and the electromagnetic vibration frequency of the photons is given by $E = h\nu$, where h is Planck's constant and ν is the Greek letter denoting the frequency of the photon's electromagnetic wave. The trick in atomic clock metrology is harnessing the frequency of these photons while producing minimum perturbations on the natural atomic resonance.

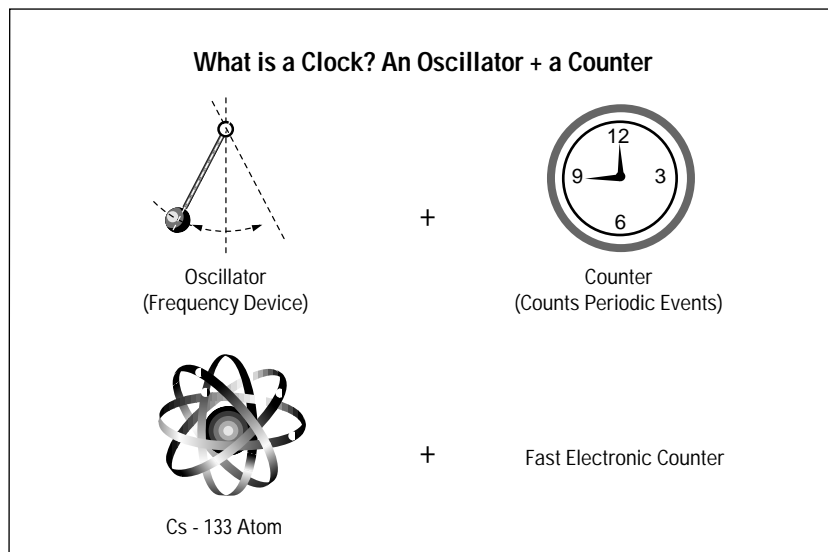

Figure 1. Almost any clock is a two-part device. The first part provides equally-spaced periodic events as derived from and defined by some oscillating device. The second part adds up these events (an accumulation of these time intervals) to provide time from the clock.

As an example of this first part of a clock, a pendulum's theoretical frequency is given by

$$\nu = \frac{\sqrt{g / \ell}}{2\pi}$$

where g is the gravitational acceleration at the location of the pendulum and ℓ is the length of the pendulum *bob's* support wire. Specifically, an ideal pendulum that swings through its lowest point once per second (one full cycle every two seconds, 0.5 Hz) will have a length $\ell = 99.3621$ centimeters if it is at sea level and at 45° latitude. By its nature, a pendulum clock will depend upon several parameters, including both its location and its environment since, for example, most materials expand with increasing temperature. An increase in temperature would cause the support wire to get longer and the pendulum clock to slow down.

The current official definition of the second is much more elegant and was agreed upon in 1967. It is based on the simple equation, $E = h\nu$. The energy difference is specific to a particular quantum transition in the cesium-133 atom, whose unperturbed frequency has been defined as 9,192,631,770 Hz. When the defined number of cycles transpire for the electromagnetic signal associated with the photon either being given off or absorbed by this quantum transition, we have one official *second*.

The second part of a clock is a counter (sometimes called an integrator, adder, or accumulator) that keeps track of the number of seconds or clock cycles that have occurred. This part of the clock is represented by the gears and clock face in a pendulum clock. It keeps track of hours, minutes, and seconds. After being set initially, the clock can then provide its estimate of the correct time by adding up the number of clock cycles.

In principle, if a clock were set perfectly and if its frequency or rate remained perfect, it would keep the correct time indefinitely. In practice, this is impossible for several reasons: the clock cannot be set perfectly; random and systematic variations are intrinsic to any oscillator, and when these random variations are averaged, the result is often not well-behaved; time is a function of position and motion (relativistic effects); and lastly and invariably, environmental changes cause the clock's frequency to vary from ideal. So, if a clock is measured with sufficient precision, its reading will not agree with UTC, except at the instant when it momentarily passes through the correct time which, of course, is only correct by definition or convention.

The quality of a clock depends on how well it is set, how accurate and stable its frequency is, and the degree of immunity the clock has to environmental changes. Using modern techniques, a clock coupled with a microprocessor and sensors can be made to compensate for some of its timing instabilities. The quartz crystal oscillator provides a cost-effective means of achieving reasonably good clock stability, and properly interfaced with a computing capability and set of sensors, it

can be very effective [4]. Typically, atomic clocks are much less sensitive to environmental changes but significantly more expensive. In addition, the intrinsic nature of atomic clocks usually yields a more accurate estimate of correct frequency for the determination of the *second*. The choice of which clock is most appropriate for a given application should be considered from a systems point of view.

Four useful measures for describing the quality of a clock are: frequency accuracy, frequency stability, time accuracy, and time stability. These measures are not all independent. A clock's frequency (or rate) accuracy is how well it can realize the defined length of the *second*. A commonly-used measure is the change in the error of a clock's time divided by the elapsed time, t , over which the change occurred. This is often called the fractional or normalized frequency departure, $y(t)$, and is a time-dependent, dimensionless number. The goal of the Harrison chronometers was to have $y(t)$ less than three seconds per day, $3/86400 = 3.5 \times 10^{-5}$. The best primary frequency standards in the world today have $y(t)$ values less than 1×10^{-14} . Of course, the smaller the number, the better the clock. (See Appendix A for more details regarding these measures.)

Frequency stability, on the other hand, indicates the change in frequency from one period of time to the next. A clock can have a significant frequency error and still be very stable; in other words, the frequency or rate error stays about the same. For example, a clock may have a rate inaccuracy of gaining one second a day, but if that rate remains the same, it would have perfect frequency stability. Two very important kinds of atomic clocks, a hydrogen-maser and a cesium-beam, are good examples of clocks having different stabilities and accuracies. A hydrogen-maser clock typically has better frequency stability than a cesium-beam clock from second to second or from hour to hour, but often not from month to month and longer. On the other hand, the typical cesium-beam clock is more accurate than the hydrogen-maser clock. Quartz-oscillator based clocks can be very stable for short times, but they drift in frequency and don't have the frequency accuracy of atomic clocks.

Time accuracy by definition means how well a clock agrees with UTC. There are often cases where what is needed is consistency of time at several locations in a system. What may be important is the time accuracy of each of the clocks with respect to the system. This is exactly the case for the U.S. Department of Defense's (DoD's) Global Positioning System (GPS) whose time differs from UTC. Specifically, the GPS time broadcast by each of the satellites needs to be synchronous with all of the other satellites in the constellation to within a small number of nanoseconds in order for the system to work properly. This is accomplished for GPS by the presence of atomic clocks on board the satellites. The telecommunications industry is another classic example, where large amounts of data are being transported among many network nodes. These nodes need to be carefully synchronized or data will be lost or transmissions will be faulty (a missing line in a FAX, for example).

Time stability is usually correlated with frequency stability, but it is often useful as a measure of changes with respect to some uniform flow of time in time-measurement systems and/or time-distribution or time-dissemination systems. For instance, consider the clock mentioned before, which gains one second a day and does this day after day. While its time accuracy may be degrading a second a day from its initial setting, it would have perfect frequency stability, and consequently perfect time predictability. If the time or frequency errors of a clock can be estimated, then compensating corrections can be made. If the time and rate (frequency) of a clock with good stability are calibrated against some better clock, then an estimate of that better clock's reading can be used should the better clock not be available. In a hierarchy of calibrations, at the peak of the pyramid are the primary reference standards. In the case of a Primary Frequency Standard, "primary" means it can provide the length of the second independently. In determining their accuracy, some Primary Frequency Standards are taken through a series of measurement cycles to obtain a best estimate of the second; this often precludes these standards from running continuously as is needed for clock operation. In such a case, the technique of having a secondary clock that has been calibrated in rate by a Primary Frequency Standard allows the secondary clock to perpetuate an estimate of the time of the Primary Frequency Standard, had it been operating as a clock on a continuous basis. This is an important technique in timekeeping that is used extensively in the generation of UTC.

Moving from astronomical time to atomic time evoked many new concepts. One very important concept is the power of properly used clock ensembles. Historically, astronomical time was based on the movements of one Earth, one moon, one sun, one solar system, and one celestial sphere of moving stars and planets. Time was deduced from the dynamical equations of motion of these objects. Even though there was only one of each, reliability was never an issue; the earth was not expected to stop spinning! With the introduction of atomic clocks, there were now many timekeepers — each of which could generate its own estimate of time. The concept of a clock ensemble had great merit from the standpoints of reliability and performance. One clock can stop. From measuring the time difference between two clocks it is impossible to tell which one is deviating. Three independent clocks allows an independent estimate of the stability of each, but four are needed in case one should quit. Further, it has been shown that if the clocks are well characterized (see Appendix A), and optimum weightings are given to them in a properly developed combining algorithm, the weighted ensemble can have better performance than the best clock in the set and even the worst clock will enhance the ensemble output. If a clock fails or has a bad reading, it can be detected and rejected so that it does not adversely perturb the ensemble's output. A very reliable and stable real-time output can be generated by such an ensemble. The first real-time output clock ensemble was developed at the National Institute of Standards and Technology in Boulder, Colorado in 1968, and essentially all of the timing centers currently use clock ensembles to generate their official timing reference [5].

Measuring and comparing time and frequency of clocks remote from each other can be accomplished in a wide variety of ways and with a variety of accuracies and stabilities. Usually, the better the accuracy and stability, the more expensive will be the system. During the last two decades with the advent of the Global Positioning System, great progress has been made in transporting time and frequency. With the atomic clocks on board the satellites, GPS acts like a portable clock in the sky, continuously available anywhere on Earth via very inexpensive receivers. Accuracies better than one microsecond (one millionth of a second) with respect to UTC are readily available by the proper use of GPS timing receivers. Satellite techniques, in general, have demonstrated significant advantages over terrestrial techniques, such as improvements in accuracy, integrity, availability, continuity, coverage of service, and perhaps more importantly, cost.

To measure time precisely, we must account for the delay between the clock and the user. For example, when you look at a clock, you don't see what time it is, but what time it was when the light that reflected the time toward your eye left the clock. This is like the delay of sound; the lightning is seen and then the thunder is heard. The speed of sound is about a million times slower than the speed of light. Light travels 30 centimeters (about one foot) in a nanosecond, so the delay for a clock in the same room as the observer is only several nanoseconds. This delay for GPS satellite orbits is of the order of 70 milliseconds (thousandths of a second). In telecommunication networks, these delays can be very important. GPS timing receivers estimate and account for the signal-propagation delay from the satellites to the receiver.

From the above, it is apparent that the performance one sees from a clock is affected by signal propagation variations and delays, changes intrinsic to the clock, and environmental perturbations on the clock (see Figure 2). See Appendix A for a more detailed discussion of accuracy, stability, precision, and uncertainty in specifying clock performance.

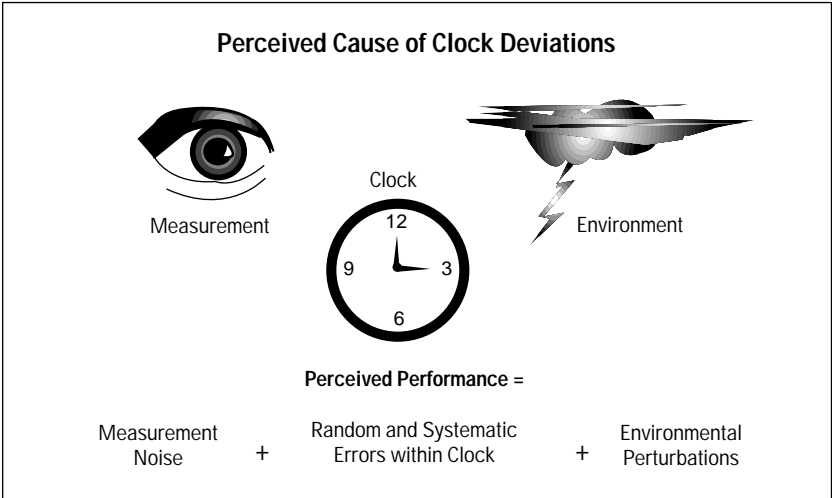

Figure 2. What we perceive as the time from a clock is influenced by three things: first, by the perturbations on the time signal as it is communicated from the clock to the receiver of the time information; second, by the variability of the timing intrinsic to the clock itself; and third, by the environmental (external) perturbations that cause variability in the clock's timing.

The Definition of the Second and its General Importance

In 1967, it was agreed by the 13th General Conference of Weights and Measures (CGPM [Conférence Générale des Poids et Mesures] Resolution 1) that: “The second is the duration of 9,192,631,770 periods of the radiation corresponding to the transition between the two hyperfine levels of the ground state of the cesium-133 atom.” The current best accuracy for the realization of the second so defined is a value “ $y(t)$,” as defined above, of 3×10^{-15} [6]. This is equivalent to ± 1 second in 10 million years.

At the time of the definition, the atomic second was made to agree as much as possible with the ephemeris second based on astronomical measurements. The 9,192,631,770 Hz assigned to the above cesium transition was the result of a three-year cooperative between L. Essen at the National Physical Laboratory (NPL) in Teddington, England and W. Markowitz at the U.S. Naval Observatory (USNO) in Washington, D.C. NPL supplied the cesium clock, and USNO provided the astronomical measurements via a clever dual-rate moon camera which could simultaneously compensate for the different movement of the moon and the stars [7]. The occultation of the latter by the former gave a very accurate estimate of ephemeris time. The commonly received transmissions of the National Bureau of Standards time and frequency radio transmission on WWV were used to relate the two times.

A very accurate frequency has three principle advantages over the other base standards in metrology: first, no other standard can presently be measured so accurately; second, high levels of accuracy and stability can be obtained relatively inexpensively; and third, it can be communicated via electromagnetic waves (as in radio transmission, microwave transmission and laser transmission). With the development of these time and frequency techniques, it is not surprising that there has been a dramatic increase in the use of precise timing over the last few decades, and this trend is expected to continue. GPS is a classic example.

All high-accuracy radio navigation systems employ precise and accurate timing. Telecommunication systems require precise network synchronization. The electric power grid uses precise timing for efficient power flow and for fault detection. Computer networks require precise timing. The banking and business industries are increasingly using precise timing to time-tag transactions. Transportation system problems are increasingly being solved by turning to precise timing techniques. Atomic clocks are at the heart of GPS, and world-wide avionics is moving towards adopting GPS as an important auxiliary navigation tool. In the long-term planning for the U.S., GPS will be the sole means of navigation.

Historical Perspective

Historically, in an agrarian society, timing was tied to sunrise, sunset and the seasons, and astronomical observations provided both parts of the clock: the frequency standard (one cycle per day for the earth's

spin) and the counter (calendar). Toward the end of the 19th century, the improved accuracy of the astronomical measurements of Simon Newcomb demonstrated that the exact fractional number of days in a year varied from year to year. It was later determined that the length of the day changes at a level of about 1.5×10^{-9} for $y(t)$ from day to day or from year to year. In addition, there is an apparent decrease in the spin rate of the earth of about 2×10^{-10} per year.

Because of the irregularities in the spin rate of the earth, a series of time scales evolved [8]. The tilt of the earth with respect to its orbital plane around the sun combined with its non-circular elliptical orbit gives rise both to the seasons and to the “equation of time.” A visual display of this equation is often shown on globes as a figure-eight pattern, the Analemma, showing the path of the sun at exact 24-hour intervals over the course of a year. If, for example, you had a perfect clock at the Greenwich meridian and looked up at exactly noon each day according to the time on the clock, you would observe the sun wandering back and forth in an East-West angle about ± 4 degrees (± 16 minutes for the clock’s reading) during a year’s time. Correcting for the equation of time yields UT0 or mean solar time. Astronomers and navigators also need to correct for polar motion as the earth wobbles with respect to its spin axis. These corrections give the time scale UT1 — the most useful time scale for knowing the earth’s angular position with respect to the heavens (celestial sphere). Careful measurements show an annual and a semi-annual variation in UT1; correcting for these periodic variations yields the time scale UT2. This was done in an effort to make a smooth time scale based on the spin rate of the earth. The irregularities of the earth’s spin rate around the UT2 time scale are random and cannot be predicted to better than the 1.5×10^{-9} level, which gives rise to a time prediction error of about 60 milliseconds over the course of a year. In contrast, UTC has a time error predictability of about 60 nanoseconds — a million times better.

In 1960 these irregularities in the spin rate of the earth led to a new definition of the second. Prior to this time, since there are 86,400 seconds in a day, the second was defined as “1/86400 of a mean solar day.” The new definition used as its frequency standard the one-cycle-per-year orbit period of the earth around the sun along with other astrometric data, such as the orbit period of the moon around the earth. The second was redefined as “the fraction 1/31556925.9747 of the tropical year 1900 January 0 at 12 hours ephemeris time.” This definition, the ephemeris second, was the official length of the second from 1960 until 1967 when the atomic second, based on a hyperfine transition in cesium, was introduced. The ephemeris second was difficult to measure and required one-year averages. In contrast, the atomic second could be measured in timescales on the order of one-to-ten days.

The idea of an atomic clock was actually conceived in the early 1940s by Nobel laureate I. I. Rabi. The first atomic clock, based on a microwave resonance in the ammonia molecule and using the microwave photon-absorption principle, was introduced to the world in 1949 by Harold Lyons of the National Bureau of Standards (then based in Washington D.C.). Its stability was not much different from that of the

spin rate of the earth, and it did not remain in operation as a useful working clock, but it was an important philosophical and scientific step. In the early 1950s, Lyons' group researched the possibility of using a cesium beam as an atomic frequency standard. This pioneering work demonstrated the potential for high-accuracy atomic frequency standards. However, this development was never turned into an operating atomic clock. In other words, the second part of the clock — a continuous and indefinite accumulation of atomic seconds — was not incorporated.

It was not until June of 1955 that L. Essen and J. V. L. Parry of the National Physical Laboratory in Teddington, England introduced the first operating atomic clock — also based on cesium. Over the next several years, the improved accuracy and uniformity of cesium-beam clocks became readily apparent, and the world community was ready for a new definition. Hence, in October of 1967 at the 13th convocation of the General Conference of Weights and Measures, it was declared that: "The second is the duration of 9,192,631,770 periods of the radiation corresponding to the two hyperfine levels of the ground state of the cesium-133 atom." This particular cesium resonance was agreed upon under *la Convention du Mètre* and remains to the present time as the official definition of the second for the world community. Fortunately, the choice of cesium for the definition was a good one, and it is evident that this definition is likely to remain with us for some time to come. It has been well commercialized; cesium-atomic clocks now number in the thousands.

Atomic clocks have improved dramatically since their introduction — by a factor of about one million since being introduced in the late 1940s. As technology has moved to the foreground of society, these new and improved clocks are being used on an ever-broadening basis. An interesting set of problems has arisen during the move from a society using astronomical phenomena for timing to a society where atomic timekeeping techniques are becoming ever more important. One problem with the current definition of the second is that it was made to agree with the ephemeris second, which ties back to the year 1900. The spin rate of the earth is very erratic as compared to atomic clocks, and it is very difficult to arrive at a well-defined slowing-trend value. For example, over this century the variations are so large that it is difficult to see any trend at all. Over the last 400 years, the decreasing spin rate is about -1.1×10^{-10} per year. The long-term data for Earth spin rate taken from S. K. Runcorn's work using coral growth as paleontological clocks yields a decreasing spin rate of -2.5×10^{-10} per year. Using the definition for the ephemeris second as the earth's rate in 1900, the earth has slowed down about 62 seconds between 1900 and 1996 — 32 of those seconds between 1900 and 1958 when atomic time was set synchronous with Universal Time and the remaining 30 between 1958 and 1996. Again, because of the relatively large fluctuations of the earth's spin rate, this number has little meaning. If, for example, this 62 seconds is used to calculate a rate of decrease, we obtain -4.3×10^{-10} per year, which makes little sense given the other values. In a different way of looking at this problem, if the current cesium-based definition reflected more nearly the current spin rate of the earth, the divergence between UT1 (Earth time) and UTC would be

about ten times less, but we have no guarantee that the current Earth spin rate will continue. At the present time, the earth is running slow about a second a year. Precision time and frequency metrologists are satisfied with the excellent performance of atomic clocks. However, navigators and astronomers need to know Earth angular position or Earth time, UT1.

An Illustrative Timekeeping Example

As was shown in Figure 2, there are three things that can cause deviations in the observed time of a clock: measurement noise, internal clock deviations, and external environmental perturbations affecting the clock. The internal clock deviations can arise either from deviations in the clock's frequency standard (pendulum-like device), or in its counting mechanism which keeps track of the measured time intervals. The following experiment was conducted to illustrate these different deviation mechanisms. We purposely purchased three of the cheapest stopwatches from a local department store — costing about six dollars each. We chose watches with 1/100-second readout capability. The readout was a liquid crystal display (LCD). The internal frequency reference was the typical quartz tuning-fork oscillation of 32,768 Hz. The three stopwatches were attached side-by-side to a board so that they could be observed simultaneously.

To measure the readings of the three clocks, we mounted a camera in front of the board and used a 1/1000-second shutter speed. Once each day a telephone call was made to the Atomic Clock in Boulder, Colorado and the camera-shutter button was pushed as near as was humanly possible to align with the 14:00:05 UTC tick from the atomic clock. The experiment was set up in the living room of one of the authors, Neil Ashby who lives in Boulder, Colorado. This time corresponded to five seconds after 7:00 a.m. Mountain Standard Time. The five-seconds-after-the-hour delay was chosen so that the one-second beat could be sensed to obtain the most accurate triggering of the camera shutter. Measurements were taken once each day for 145 days.

The main environmental effect was just the seasonal temperature of the living room. Pressure, humidity, shock and vibration effects were probably negligible compared to the temperature effects.

Ashby also plays the piano, and we hoped his musical training would assist in minimizing the trigger-time measurement noise as he operated the camera. In theory, the 1/1000-second (1 millisecond) shutter speed should easily stop the LCD readout, since it only changes every 10 milliseconds (1/100-second). However, in many cases, the LCD readouts were caught in transition.

Appendix A explains some of the details of the tools used to analyze the data. Once we developed the film, we extracted the readings of each of the three clocks with a readout precision of 10 milliseconds (ms) and a reading once per day. The theoretical standard deviation on 10 ms rollover precision is only 2.9 ms. Contributions to the measurement noise will also come from the precision with which the shutter is

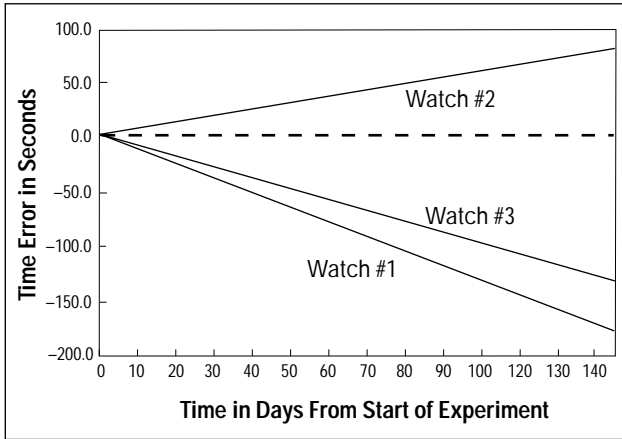

Figure 3. A plot of the time error of three stopwatches with data taken daily for 145 days.

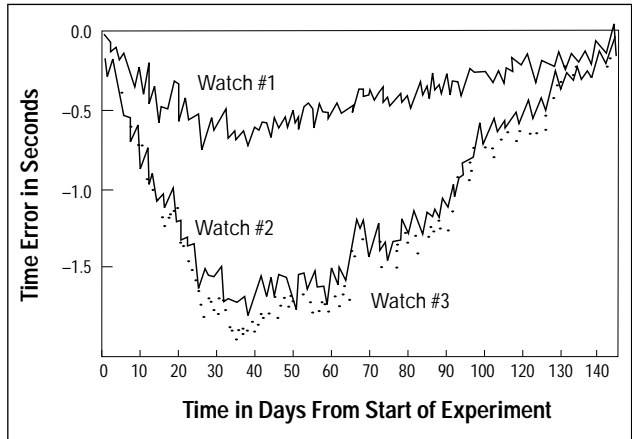

Figure 4. After calibrating the clock rate (frequency) for each of the three stopwatches, these rates were subtracted from the data and the residual time errors are shown here.

pushed plus the delay in the atomic-clock signal across the telephone line. Since the experiment was also in Boulder and only one telephone exchange office processed the call, this delay should be the order of a millisecond. We therefore have a near perfect time reference as compared with all the other time-deviation mechanisms observed in this experiment.

The clocks were synchronized with the Boulder atomic clock at the beginning of the experiment. Figure 3 is a plot of the daily time errors including the initial point when the three clocks were synchronized. The frequency accuracies of the three clocks were: -1.17 , $+0.48$, and -0.81 seconds per day for clocks 1, 2, and 3 respectively. If these rates are divided by the number of seconds in a day ($86,400$ s/day) we obtain the dimensionless frequency inaccuracy for each of the three clocks: -1.36×10^{-5} , $+0.56 \times 10^{-5}$, and -0.94×10^{-5} , respectively. These values are typical for stopwatches of this quality. A wristwatch has the advantage of being controlled by the body's temperature, and the quartz crystal is usually preset to run on the correct frequency at this temperature.

If we now use the Boulder atomic clock to calibrate the rate of each of the three clocks and remove these rate offsets per the above numbers, we then observe the residual errors shown in Figure 4. It will be noticed that these errors, on a peak-to-peak basis, are nearly a hundred times smaller than those shown in the previous figure. A high degree of long-term correlation is also observed between the three clocks — especially between clocks 2 and 3. This probably is due to their being subject to the same temperature environment and having very similar temperature dependence.

The effect of frequency drift, D , is also evident in Figure 4 as can be seen by the parabolic shape of each of the three curves. For the kinds of noise processes encountered in this experiment, a simple and near-optimum estimate of the drift is given by $D = 4[x(N) - 2x(N/2) + x(0)]/T^2$, where $x(0)$, $x(N/2)$, and $x(N)$ are the clock's time residual errors at

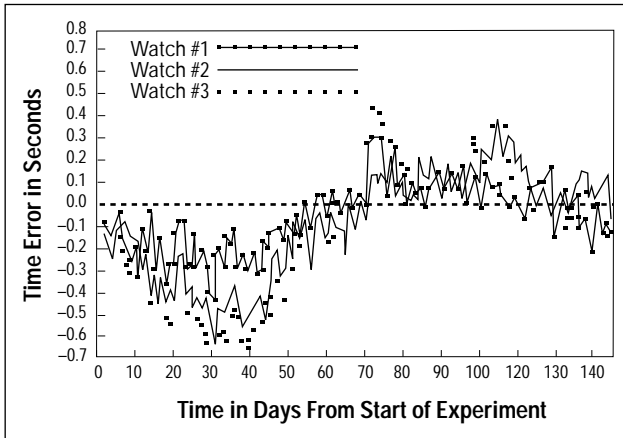

Figure 5. After subtracting calculated frequency offsets and frequency drifts from the data, we obtain the time error residuals shown here.

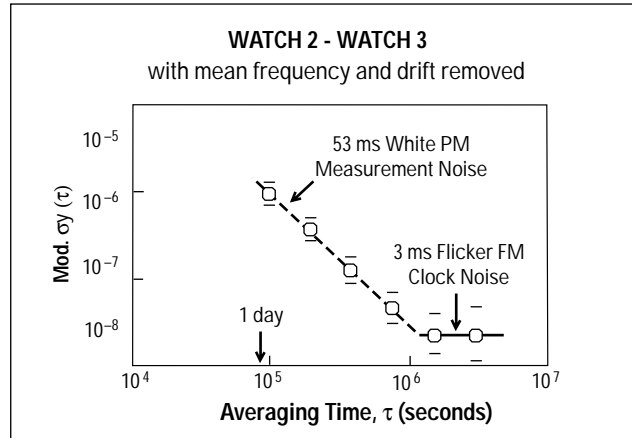

Figure 6. If we now analyze the frequency stability of series 2 minus series 3 using the methods developed in Appendix A, we obtain the plot shown here.

the beginning, in the middle and at the end of the data, respectively, and T is the total time duration of the data set — in our case 145 days. If the drift for each of the three time series is calculated and subtracted from the data, we have the time error residuals shown in Figure 5.

Let's denote the residual time error shown in Figure 5 as three time series $x_1(i)$, $x_2(i)$, and $x_3(i)$ for each of the three clocks with the i designating the day count from the beginning of the experiment. As explained in Appendix A, we can calculate the day-to-day time stability for each of these three time series and we obtain 48 ms, 52 ms, and 54 ms, respectively. These values will be the sum of the shutter-trigger time noise, the LCD rollover noise, and the quartz tuning-fork noise (measurement noise + counter noise + frequency standard noise). Of course, the frequency standard's deviations can come from internal mechanisms or be driven by the environment. At this point, we cannot deduce how much is coming from each of these different sources. As will be shown in Figure 6, at an averaging time of 1 day, the measurement noise is well above the crystal oscillator noise. In this case as was implemented above, a three-point frequency drift estimator can be shown to be a simple and efficient estimator, where the three points are the first, middle and last time-error points. Having removed the mean frequency to obtain the residual time error data for Figure 4 results in the first and last point being zero. Hence, the above equation for the frequency drift can be simply obtained by $D = -8 x(N/2)/T^2$, where $x(N/2)$ is the middle time-error point and T is the data length. The residuals shown in Figure 5 are probably made up of measurement noise, correlated effects driven by a common temperature for all three stopwatches, and long-term random variations of the quartz crystal oscillators.

Since the data were taken each day at the same moment within 1 ms, we can subtract one time series from the other on a day-by-day basis. The effect of the shutter-trigger noise will cancel in these differences since the error is identical to within 1 ms. We can write the difference $x_{12}(i) = x_1(i) - x_2(i)$, etc. for $x_{13}(i)$ and $x_{23}(i)$. In the case of random-

uncorrelated deviations, the cross variances average to zero, and we may solve for the unknown variances with the following equations:

$$\sigma_1^2 = \frac{1}{2} \left[\sigma_{12}^2 + \sigma_{13}^2 - \sigma_{23}^2 \right], \quad \sigma_2^2 = \frac{1}{2} \left[\sigma_{12}^2 + \sigma_{23}^2 - \sigma_{13}^2 \right] \text{ and}$$

$$\sigma_3^2 = \frac{1}{2} \left[\sigma_{13}^2 + \sigma_{23}^2 - \sigma_{12}^2 \right].$$

We have here three equations with three unknowns. Solving for these variances and taking the square root yields day-to-day time stabilities for the LCD rollover noise of: 27 ms, 40 ms, and 36 ms, respectively, which is much larger than the theoretical value of 2.9 ms. At this point, we may wonder if this is clock noise. We will show later that it is not.

We may also write the above time difference equations as $x_{12}(i) = [x_{L1}(i) - x_{L2}(i)] + [x_{C1}(i) - x_{C2}(i)]$, and so forth, with the first bracketed term representing the LCD rollover error and the second the clock error. Taking the difference between these series also has the advantage of subtracting the effects due to temperature if each series is affected the same way. If we have removed the correlated deviations and most of the systematics, we are left with the random uncorrelated deviations.

We can now deduce the shutter-trigger noise — how well our piano finger follows the Boulder atomic clock. By squaring the total day-to-day time stability given earlier for each of the three time series and then subtracting the estimated variance for the LCD rollover noise just deduced, we end up with an estimate of the variance for the shutter-trigger measurement noise. Taking the square root of these calculations yields 40 ms, 33 ms, and 40 ms respectively. Taking an average of the three variances and taking the square root yields 38 ms for how well a person can push a button in synchronism with an accurate time signal.

As mentioned before, the correlated effects (probably due to temperature) and the shutter-trigger noise are largely removed from this set of time differences. In Figure 6, you will notice that the first part of the plot has a slope of $\tau^{-3/2}$; as explained in Appendix A, this slope is consistent with random and uncorrelated measurement noise. This kind of noise is not observed for clock deviations for this range of averaging times. In the long-term it will be noticed that the slope is more like τ^0 . This slope is characteristic of flicker-noise frequency modulation and is typical for clocks. If this τ^0 slope is extrapolated back to $\tau = 1$ day, we see a level that would correspond to about 3 ms of time stability noise. Hence, the reason for ignoring the random, uncorrelated clock noise in the earlier calculations for the day-to-day stability estimates of LCD and shutter-trigger noise contributions.

We see the very exciting conclusion that if these inexpensive clocks are calibrated and the systematics are removed, their timekeeping ability improves dramatically: from hundreds of seconds per year to the order of one second per year. The technology exists today to perform such calibrations and systematic error removal automatically. When this is implemented, we will see a dramatic improvement in the

common inexpensive watch. Such a watch would always be correct — within some very small error limit — and would never need to be reset. A patent has been awarded that explains how this could be done (United States Patent Number 5,274,545). The HP SmartClock technology employs some of the ideas in this patent — plus some others — to obtain its atomic-clock-like performance from a quartz-oscillator GPS receiver-based product.

UTC: Official Time for the World

Because most users want official time to tie to Earth time, a dilemma arises. Precision time and frequency users want the most uniform and accurate time possible, yet the earth speeds up and slows down and is not useful for precision metrology. Hence, a decision was made to make UTC a compromise time scale. The changes due to instabilities in the earth's spin rate would be accommodated by employing leap seconds, while on the other hand, the UTC second would be kept as close as possible to the definition based on the cesium atom. This approach became official time for the world starting January of 1972. By international agreement, a leap second may be introduced at the end of any month. However, the preferred dates are at the end of June and the end of December when required. They are introduced when necessary to keep UTC within 0.9 seconds of Earth time (UT1), and there have been 21 leap seconds added between January 1, 1972 and July 1, 1997 — an average of a little less than one a year. This average value has little meaning, however, because of the random variations in the earth's spin and because there is a nominal slow down in the earth's spin rate as well. At the estimated rate of decrease, the earth would lose about $\frac{1}{2}$ day after 4,000 years, and about two leap seconds a month would be needed to keep UTC in step with Earth time, UT1.

The work to generate UTC is performed at the Bureau International des Poids et Mesures at the Pavillon de Breteuil, F-92312 SEVRES Cedex, France, near Paris [9, 10, 11]. The staff doing the work is composed of several international timing experts who frequently interact with, and obtain timing data from, the rest of the world's time and frequency community. The leap second steps are determined by the International Earth Rotation Service (IERS), which operates out of the Paris Observatory and which collects Earth rotation data from numerous observatories and radio telescopes around the globe.

UTC was set synchronous with UT1 at 0000 hours on January 1, 1958, and until 1972, a different technique was used to keep UTC in close agreement with UT1. During that time, both frequency steps and 0.1-second time steps were used to chase the instabilities in Earth time. Table 1 lists the steering corrections introduced to keep UTC in reasonable agreement with UT1.

UTC is generated after the fact because of the goal to have its second be as close as possible to the definition and the goals of uniformity and reliability. These goals are achieved by taking the times of about 230 clocks from 65 different laboratories scattered around the world and

Table 1. Frequency Offsets and Step Adjustments of UTC, until 1 July 1997

Date (at 0h UTC)		Offsets	Steps
1961	Jan. 1	-150×10^{-10}	
1961	Aug. 1	"	+0.050 s
1962	Jan. 1	-130×10^{-10}	
1963	Nov. 1	"	-0.100 s
1964	Jan. 1	-150×10^{-10}	
1964	Apr. 1	"	-0.100 s
1964	Sep. 1	"	-0.100 s
1965	Jan. 1	"	-0.100 s
1965	Mar. 1	"	-0.100 s
1965	Jul. 1	"	-0.100 s
1965	Sep. 1	"	-0.100 s
1966	Jan. 1	-300×10^{-10}	
1968	Feb. 1	"	+0.100 s
1972	Jan. 1	0	+0.107 7580 s
1972	Jul. 1	"	-1 s
1973	Jan. 1	"	-1 s
1974	Jan. 1	"	-1 s
1975	Jan. 1	"	-1 s
1976	Jan. 1	"	-1 s
1977	Jan. 1	"	-1 s
1978	Jan. 1	"	-1 s
1979	Jan. 1	"	-1 s
1980	Jan. 1	"	-1 s
1981	Jul. 1	"	-1 s
1982	Jul. 1	"	-1 s
1983	Jul. 1	"	-1 s
1985	Jul. 1	"	-1 s
1988	Jan. 1	"	-1 s
1990	Jan. 1	"	-1 s
1991	Jan. 1	"	-1 s
1992	Jul. 1	"	-1 s
1993	Jul. 1	"	-1 s
1994	Jul. 1	"	-1 s
1996	Jan. 1	"	-1 s
1997	Jul. 1	"	-1 s

combining their readings in a near optimum way. This provides uniformity (stability) and reliability. Additionally, the length of the second is currently being determined by evaluations from 11 laboratory cesium-beam primary frequency standards. A weighted combination of these primary frequency standards is taken according to the individual accuracies to obtain an overall world-best estimate for the second. The time scale generated from combining this international set of clocks and primary frequency standards from around the world is called International Atomic Time (TAI — Temps Atomique International).

Table 2. Relationship Between TAI and UTC

Limits of Validity (at 0h UTC)				TAI - UTC (in seconds)	
1961	Jan. 1 - 1961	Aug. 1	1.422	8180 + (MJD - 37300)	$\times 0.001\ 296$
1961	Aug. 1 - 1962	Jan. 1	1.372	8180 + " "	
1962	Jan. 1 - 1963	Nov. 1	1.845	8580 + (MJD - 37665)	$\times 0.001\ 1232$
1963	Nov. 1 - 1964	Jan. 1	1.945	8580 + " "	
1964	Jan. 1 - 1964	Apr. 1	3.240	1300 + (MJD - 38761)	$\times 0.001\ 296$
1964	Apr. 1 - 1964	Sep. 1	3.340	1300 + " "	
1964	Sep. 1 - 1965	Jan. 1	3.440	1300 + " "	
1965	Jan. 1 - 1965	Mar. 1	3.540	1300 + " "	
1965	Mar. 1 - 1965	Jul. 1	3.640	1300 + " "	
1965	Jul. 1 - 1965	Sep. 1	3.740	1300 + " "	
1965	Sep. 1 - 1966	Jan. 1	3.840	1300 + " "	
1966	Jan. 1 - 1968	Feb. 1	4.313	1700 + (MJD - 39126)	$\times 0.002\ 592$
1968	Feb. 1 - 1972	Jan. 1	4.213	1700 + " "	
1972	Jan. 1 - 1972	Jul. 1	10	(integral number of seconds)	
1972	Jul. 1 - 1973	Jan. 1	11		
1973	Jan. 1 - 1974	Jan. 1	12		
1974	Jan. 1 - 1975	Jan. 1	13		
1975	Jan. 1 - 1976	Jan. 1	14		
1976	Jan. 1 - 1977	Jan. 1	15		
1977	Jan. 1 - 1978	Jan. 1	16		
1978	Jan. 1 - 1979	Jan. 1	17		
1979	Jan. 1 - 1980	Jan. 1	18		
1980	Jan. 1 - 1981	Jul. 1	19		
1981	Jul. 1 - 1982	Jul. 1	20		
1982	Jul. 1 - 1983	Jul. 1	21		
1983	Jul. 1 - 1985	Jul. 1	22		
1985	Jul. 1 - 1988	Jan. 1	23		
1988	Jan. 1 - 1990	Jan. 1	24		
1990	Jan. 1 - 1991	Jan. 1	25		
1991	Jan. 1 - 1992	Jul. 1	26		
1992	Jul. 1 - 1993	Jul. 1	27		
1993	Jul. 1 - 1994	Jul. 1	28		
1994	Jul. 1 - 1996	Jan. 1	29		
1996	Jan. 1 - 1997	Jul. 1	30		
1997	Jul. 1 -		31		

The lengths of the seconds used in the generation of TAI and UTC are the same; that is, they are based on the world's primary frequency standards in the same way. Though the frequencies are the same, the times are not with the constraint that TAI minus UTC is an exact integer number of seconds. The integer number changes as leap seconds are introduced into UTC. Subtracting the right number of leap seconds from TAI yields UTC. This may be confusing to some because we speak of adding leap-seconds. But, in fact, we are subtracting a whole SI second from the uniform and monotonically increasing reading of TAI to obtain the leap-second-adjusted UTC. The appearance of adding comes because there are 61 seconds in that minute containing one. Watching a UTC clock with a stepping seconds hand when this happens, we note the hand spends two seconds on

the 60 before moving on in a regular fashion. Table 2 shows the relationship between TAI and UTC. As can be seen, $TAI - UTC = 31$ seconds as of 1 July 1997.

While the source of the second for International Atomic Time (TAI) is derived from the primary frequency standards throughout the world, the flywheel to remember the calibrations provided by these standards is the 230 or so contributing clocks. These clocks are like the counter, adder, or accumulator for the world's official time UTC. For example, if one of the 230 clocks loses 20 nanoseconds per day as averaged over the last month, there is a certain probability that this rate will continue over the current month. Hence, this clock can be used to predict the time based on the best estimate of the second as given by the primary frequency standards. Each of the 230 clocks receives a weighting factor according to its performance. The weighted average of the best estimate of current predicted time across all of the available clocks yields TAI.

It takes about one month to collect all of the data and to perform the calculations to generate TAI and UTC times. In order to obtain a real-time estimate of UTC, there are 50 timing centers around the world that generate their own current estimate of UTC. (See Table 4 for list of timing centers.) These are called UTC(k), where the "k" denotes the particular timing center. For example, UTC(NIST) and UTC(USNO MC) are the UTC estimates generated by the National Institute of Standards and Technology in Boulder, Colorado and by the United States Naval Observatory's Master Clock in Washington, D.C. NIST has responsibility for determining the length of the second for the United States as well as supplying this value to the BIPM. USNO has responsibility for supplying time and frequency for the Department of Defense (DoD). Both organizations, in diverse and non-overlapping ways, supply time for the United States and for the BIPM, and their time scales are usually synchronous to within about 20 nanoseconds [12].

When the data are reported to the BIPM, each of the 230 contributing clocks is reported with respect to the UTC(k) available to or generated by that timing center. Each UTC(k) — including a clock at the Paris Observatory — is measured over a five day average against GPS time. When these time differences are subtracted, each UTC(k) is known against the Paris Observatory clock using GPS as a transfer standard, which drops out in the subtraction [13]. These time difference data, along with the UTC(k) minus the local clock time differences, are communicated to the BIPM for the latter's calculation of TAI and UTC. The BIPM then sends out a monthly bulletin, which reports the time differences of each of the UTC(k)s with respect to UTC for the previous month to the interested user community. This bulletin is like a "report card" telling each timing center how well they have done in predicting UTC. When it is received, it tells you "officially" what time it was! What time it is is predicted, estimated and made available to the world from the different UTC(k)s in the contributing nations.

By international agreement all of the timing centers have been given a goal to keep their UTC(k)s within 100 ns (nanoseconds) of UTC. Currently, the best predictions are approximately 10 ns. A plot of some of the UTC(k)s is shown in Figure 7. Significant progress has been made within several countries toward improving the accuracy of the UTC(k)'s which provide a real-time estimate of UTC.

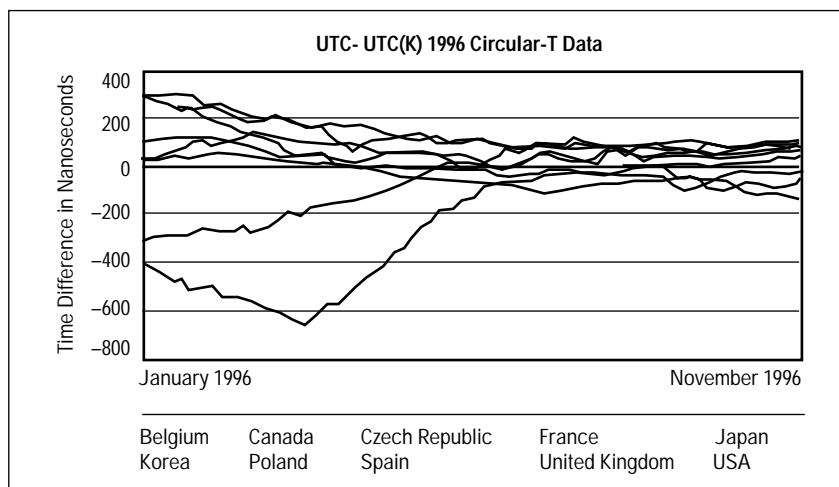

Figure 7. An example of some of the best estimates of UTC as predicted and kept by a selected set of timing centers, which also contribute data toward the generation of UTC. The agreed-upon international goal is to keep each of the UTC(k)s within 100 ns of UTC. We see significant improvement in the predicted accuracies of the UTC(k)s as time goes on. Since the timing centers have to predict UTC about 45 days in advance, the performance of the UTC(k)s allows you to calculate an implicit frequency stability of UTC of about 2×10^{-15} .

GPS Time and UTC

GPS has become the world's principal supplier of accurate time [13]. It is used extensively both as a source of time and as a means of transferring time from one location to another. There are three kinds of time available from GPS: GPS time, UTC as estimated and produced by the United States Naval Observatory, and the times from each free-running GPS satellite's atomic clock. The Master Control Station (MCS) at Falcon Air Force Base near Colorado Springs, Colorado gathers the GPS satellites' data from five monitor stations around the globe. A Kalman filter software program estimates the time error, frequency error, frequency drift and Keplerian orbit parameters for each of the satellites and its operating clock. This information is uploaded to each satellite so that it can be broadcasted in real time. This process provides GPS time consistency across the constellation to within a small number of nanoseconds and accurate position determination of the satellites to within a few meters.

Because of this process, GPS cannot tolerate the introduction of leap seconds. Hence, in 1980, when the Department of Defense started keeping time on the GPS satellites, its system time and frequency were set to agree with UTC(USNO MC). At that time, TAI minus UTC was 19 seconds (see Table 2). Since then, UTC has been delayed many leap seconds and GPS time has not. Hence, GPS time is still very close to TAI minus 19 seconds. The specification on GPS time is that it is to be kept within one microsecond of UTC(USNO MC) modulo one second. In other words, as a leap second is introduced into UTC(USNO MC)

time, no such step occurs in GPS time. But GPS time is still steered to agree as well as possible with UTC(USNO MC), as if no leap seconds had occurred since 1980. In practice, the steering performance is much better than the one-microsecond specification; typically, it is well within 40 nanoseconds.

In order to provide an estimate of UTC time derivable from a GPS signal, a set of UTC corrections is also provided as part of the broadcast signal. This broadcast message includes the time difference in whole seconds between GPS time and UTC. During 1996 GPS time minus UTC time was 11 seconds. Also included in this message is the rate and time difference estimate between GPS time and UTC(USNO MC) modulo one second. This allows a receiver, in principle, to calculate an accurate estimate of UTC(USNO MC). The mission goal is 28 ns (1σ). Outside of the purposeful current degradation of the GPS signal (called Selective Availability, SA) by the DoD for security purposes, this calculation may have an accuracy of about 10 nanoseconds (ns) on an rms basis [14]. Since USNO has been successful in predicting UTC to within about 10 ns, combining these two independent error sources yields a real-time potential uncertainty for UTC available from GPS at about the 14-ns level. In practice, SA prohibits achieving this accuracy level unless special clock systems and filtering techniques are employed. The SA degradation can be filtered away, as will be discussed later [15] (see the section below and Appendix B, see Appendix A for the meaning of uncertainty, and see Figure 14 for an illustration of SA filtering).

Accuracy and Stability of UTC

The accuracy and stability of UTC have improved dramatically over the last few years. This is primarily due to the introduction of the Hewlett-Packard HP 5071A Cesium Beam Clock. Along with having about a factor of ten better accuracy than any other commercial frequency standard, this clock also has more than a factor of ten less sensitivity to the environment — giving it outstanding long-term stability — usually well below 1×10^{-14} . The work of Leonard Cutler and Robin Giffard of Hewlett-Packard Laboratories and the design team of the HP Santa Clara Division, in regard to solving the environmental sensitivity problem in cesium-beam clocks, is reminiscent of what John Harrison did for mechanical clocks. Because of their outstanding performance, these clocks were rapidly introduced into the UTC ensemble membership by the different laboratories as they became available. As a result, the stability of UTC has improved by about a factor of ten from 1991 to 1996. With these same clocks, the timing centers are now able to do a much better job of predicting UTC. This work could well be the basis for eventually arriving at a highly accurate and extremely stable real-time UTC. Then we could know precisely what time it is!

For 1995, Figure 8 shows the frequency distribution of all the clocks contributing to UTC. Figures 9 and 10 show the distributions of the HP 5071As and the primary frequency standards, also contributing

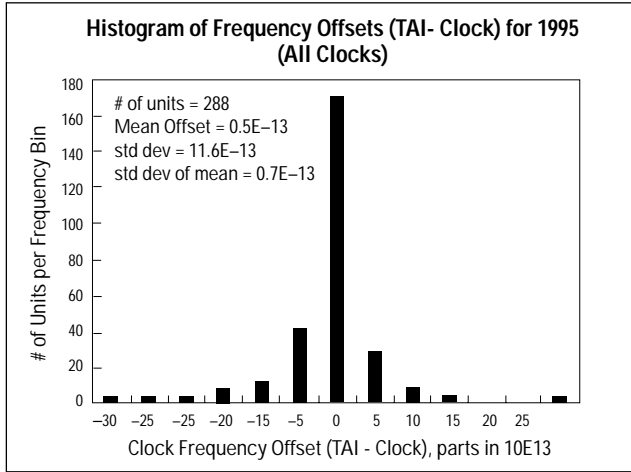

Figure 8. A histogram showing the frequency accuracy of all the clocks contributing to TAI and UTC with histogram box size of 5×10^{-13} .

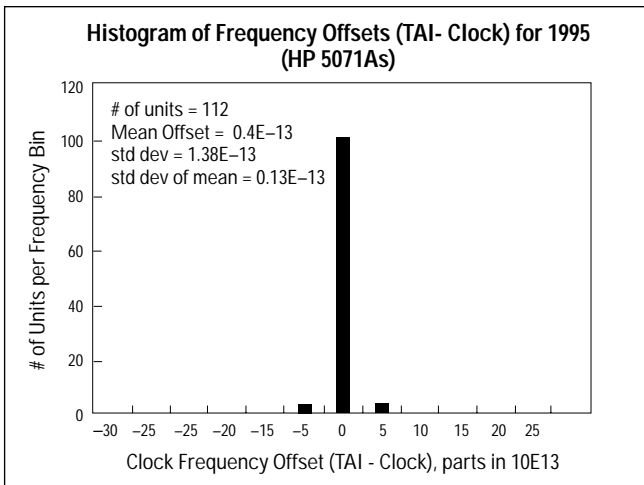

Figure 9. A histogram showing the frequency accuracy of the HP 5071As that contribute to TAI and UTC. The histogram box size is 5×10^{-13} . Notice that the mean offset is 24 times better than the HP accuracy specification for the HP 5071A, and the standard deviation is 7 times better.

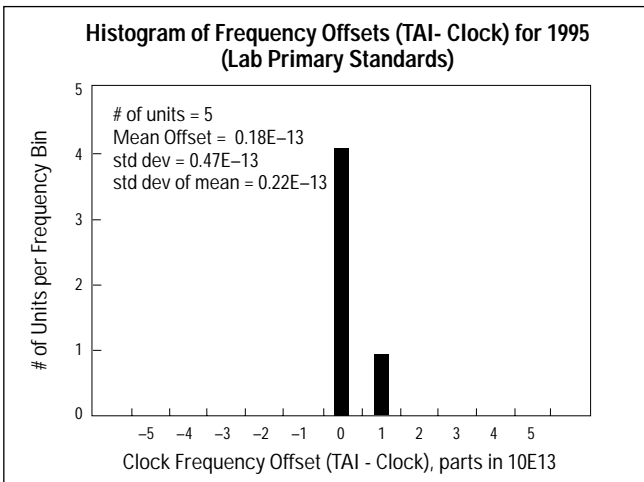

Figure 10. A histogram showing the frequency accuracy of the primary frequency standards that contribute to TAI and UTC. The histogram box size is 1×10^{-13} . The mean offset is mostly due to the 1996 CCDS decision to include the “black-body radiation” shift correction.

to UTC. Even though the standard deviation of the mean of the HP 5071As' frequencies is about the same as that of the primary frequency standards throughout the world, one may ask the question about the statistical independence of same-model-number devices. The standard deviation shown for the HP 5071As' frequencies is seven times better than the manufacturer's accuracy specification of 1×10^{-12} , and the mean value only differs by -5×10^{-14} . As can be seen from the pie chart in Figure 11, the percentage of weight assigned to the HP 5071As is more than 2/3 that for the entire UTC ensemble — even though the total number is less than half of all the contributors to UTC. This, again, is because of the excellent long-term frequency stability and time predictability of these clocks.

Also, in the last few years, the accuracies available from cesium primary frequency standards has improved remarkably. The emerging technologies that have brought about these improvements in cesium primary frequency standards are laser energy-state pumping and detection, laser cooling using photon pressure down to near absolute zero temperature, followed by a photon pressure pulse giving rise to a controlled low-velocity cesium fountain. Nearly a factor of ten improvement in accuracy has already been achieved and the end is not in sight. The cesium fountain work has been led by Andre Clairon at the Laboratoire Primaire du Temps et des Fréquences [LPTF] in Paris, France, and the laser energy-state cesium selection and detection by Robert Drullinger at the National Institute of Standards and Technology (NIST) in Boulder, Colorado. These have been major breakthroughs since Lyons developed the first cesium-beam device in the early 1950s.

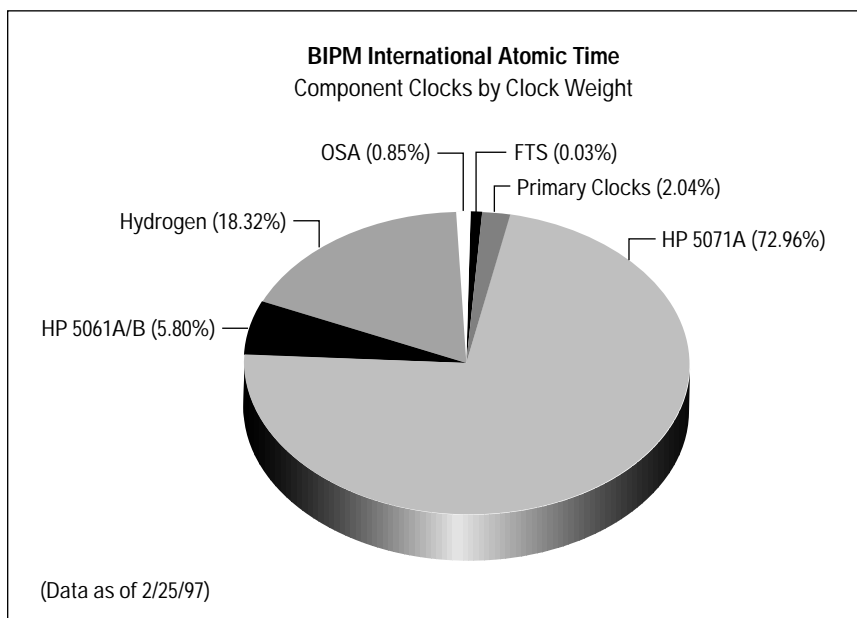
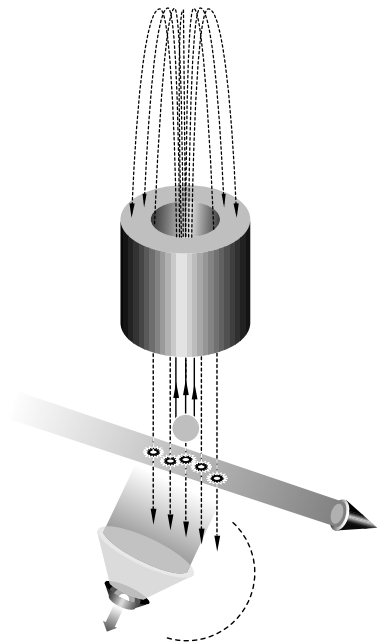

Figure 11. A pie chart showing the distribution of clocks and the assigned weighting factors assigned by the BIPM for the clocks composing the UTC time scale for the month of December 1996.

The variance used to determine the weighting factors for the TAI and UTC computation is the frequency stability taken over an averaging time of two months, and six values (one year's worth of data) are used to compute a six-sample variance. The weighting factors shown in Figure 11 are proportional to the reciprocal of the variance except that they are not allowed to exceed an upper limit of weight.

The primary standards are located in Canada (NRC CsV, CsVI A and CsVI C), France (LPTF JPO and FO1), Germany (PTB CS1, CS2, and CS3), Japan (CRL Cs1), Russia (SU MCsR 102) and USA (NIST-7). The high accuracy and continuous operation of the PTB primary frequency standards has made them major contributors to the accuracy of the SI second used in TAI and UTC [16].

Table 3 lists the uncertainties of the primary frequency standards that are used to determine the second for UTC. The current stated accuracy given by the BIPM for the second used in the generation of UTC is -2×10^{-14} with an uncertainty of $\pm 1 \times 10^{-14}$. As stated above, the only clock that is correct all of the time is the one we agree to call so. Even though there are some estimated errors in UTC, its time is correct by definition. This small inaccuracy is due to a recent decision to include an additional correction called the "black-body radiation shift."

The frequencies of these primary frequency standards are corrected for the gravitational shift (of about 1×10^{-13} for an altitude of 1000 m), and for the black-body radiation shift (of about 2×10^{-14} for a temperature of 40°C) when available (standards tagged with an *).

Table 3. Uncertainties of the Primary Standard

The characteristics of the calibrations of the TAI frequency provided by the different primary standards are as follows (file available via Internet: UTAI96.AR):

Standard	Unc. (1 σ)	Operation	Comparison with	Transfer to TAI
CRL Cs1*	1.1×10^{-13}	discontinuous	UTC(CRL)	60 d
LPTF JPO*	1.1×10^{-13}	discontinuous	UTC(OP)	10 d
LPTF FO1*	0.3×10^{-14}	discontinuous	H maser	5d or 10 d
NIST NIST-7*	0.5×10^{-14}	discontinuous	H maser	5d or 10 d
NRC CsV	$\cong 1 \times 10^{-13}$	continuous	TAI	60 d
NRC CsVI A	$\cong 1 \times 10^{-13}$	continuous	TAI	60 d
NRC CsVI C	$\cong 1 \times 10^{-13}$	continuous	TAI	60 d
PTB CS1*	3×10^{-14}	continuous	TAI	60 d
PTB CS2*	1.5×10^{-14}	continuous	TAI	60 d
PTB CS3*	1.4×10^{-14}	continuous	TAI	60 d
SU MCsR 102*	5×10^{-14}	discontinuous	UTC(SU)	60 d

The black-body radiation shift was discovered, theoretically, by Wayne Itano of NIST in 1982 [17]. It is due to the isotropic black-body radiation emitted from the surroundings of the atomic beam in a cesium atomic clock. The size of the black-body radiation shift is only -1.76×10^{-14} at 300°K (27°C). Recently, two laboratories developing the next generation of cesium fountain clocks have measured this shift, their results confirming theory [18,19]. Because the theoretical basis of the shift was sufficiently strong, the March 1996 CCDS (Comité Consultatif pour la Définition de la Seconde) decided to include this effect. This resulted in a step change in the SI second of about this amount. TAI and UTC are being gradually steered to agree with this improved value.

Although it does not exist in nature, we may conceptualize an ideal clock. If three or more independent clocks are compared, we may estimate the individual instabilities of each with respect to this ideal clock. A clock's instabilities are directly related to its predictability. Figure 12 shows the predictability of a wide variety of clocks, or their timekeeping ability. The different slopes are indicative of different kinds of random processes perturbing the timing data coming from that particular clock.

For instance, a horizontal slope results from being limited by measurement noise, which is the first kind of perturbation illustrated in

Figure 12. A comparison of the timekeeping ability of a wide variety of clocks as a function of the time since being synchronized and syntonized.

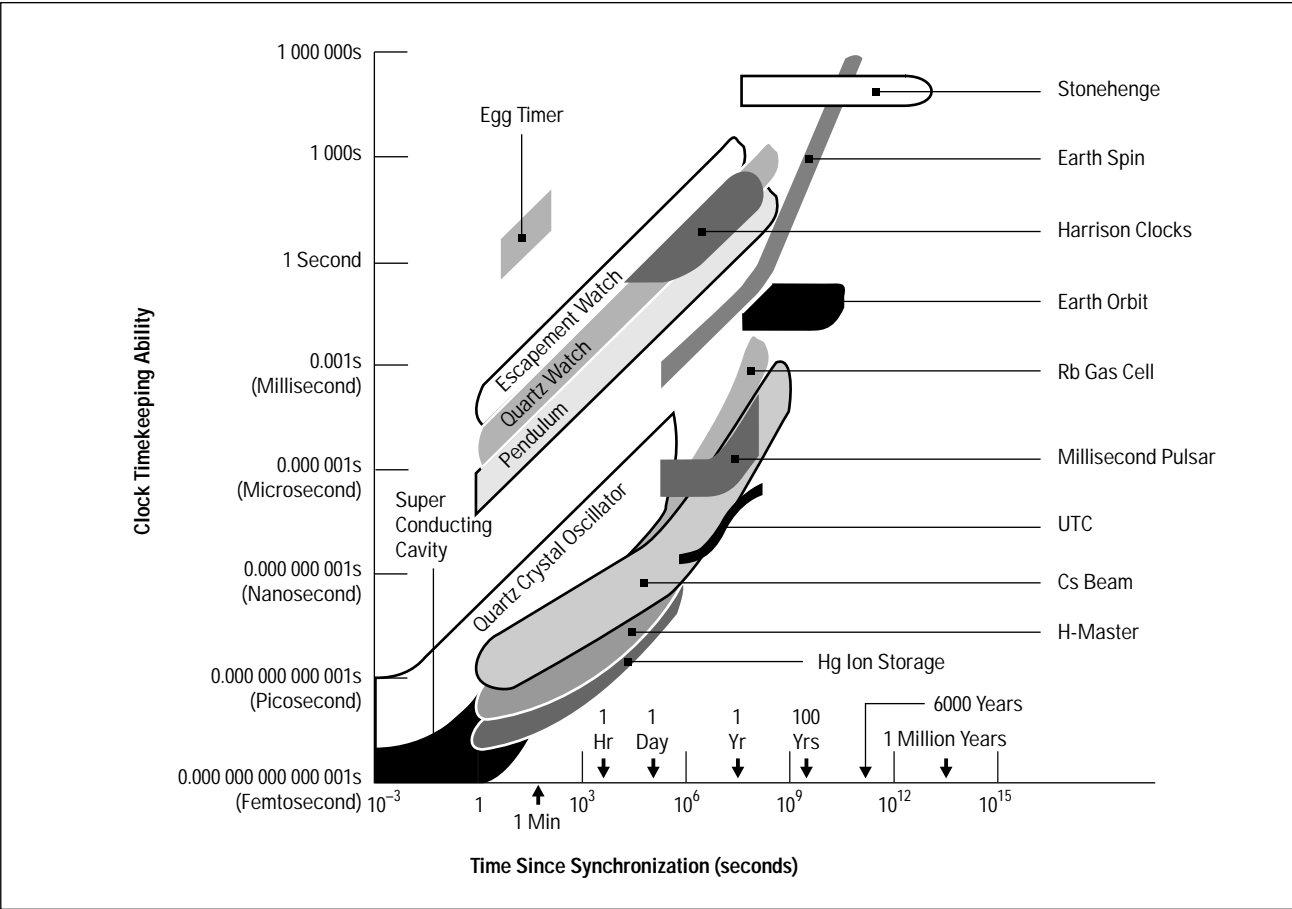

Figure 2. Data with the slopes upward are indicative of the limiting internal random perturbations affecting that clock; these are the second type illustrated in Figure 2. The third type, the effects of the environment, can be enormously important, but because of their large variety and complexity, these effects have been ignored, as much as possible, in this figure. The range of data shown is taken from several different experiments and is intended to suggest a nominal range of coverage for each designated clock type. The long-term data for Earth spin as a clock are taken from S. K. Runcorn's work using coral growth as paleontological clocks; in his estimates, for example, 600 million years ago the earth had 425 days in a year. Also plotted are estimates of the timekeeping ability of UTC. The short-term performance of UTC will improve as better time transfer techniques are perfected. The long-term performance will improve as the contributing clocks and computing algorithms improve.

For historical perspective, data from the revolutionary Harrison-like chronometers is included for comparison. See Appendix B for a more detailed analysis of the Harrison-like chronometers. Also shown is the current estimate of the timekeeping ability of UTC as a composite of many clocks. The low slope portion on the left is due to measurement noise, and the low slope portion on the right is the benefit of having primary frequency standards keeping the UTC second tied to the SI second. As it has in the past, UTC will undoubtedly continue to improve as time goes on.

In the ideal combining algorithm, the computed time of a clock ensemble can have better stability than the best clock in the ensemble. In order to accomplish this goal, the clocks have to be characterized individually; then each clock can be included in the algorithm in an optimum way. There are two practical problems with this procedure. It takes a significant amount of time to characterize each clock; this is one of the reasons the BIPM takes about a month to calculate UTC. Then, there is significant measurement noise in bringing all of the clock data into one place as is needed for the generation of UTC. Waiting for a month has the benefit of allowing the better detection and removal of anomalous errors from the data than if the time were shorter. With the clocks distributed across the globe, transporting their times to the BIPM without perturbation is a significant challenge at the nanosecond level of accuracy. Waiting also has the advantage of allowing time to average and filter the time transfer noise.

Einstein's Relativity and Precise Timekeeping

The high level of accuracy now being attained with clocks requires that relativity be included in the comparisons and computations of time and frequency relationships. For example, relativity is an engineering reality in the design and operation of GPS: GPS would not work without its inclusion [20, 21].

Relativity, without going into the mathematics, deals with three problems: the relative motion of clocks; differences of gravitational potential in which clocks find themselves; and the problem of rotating

reference frames, such as the earth on which we live. Previously, we used the term “Coordinated” — indicating an international cooperative effort. In this section, we will be using the concept of coordinate time, which refers to a consistent set of relativistic timing procedures. Thus, clocks distributed in space and time can be compared and used harmoniously without confusion as to what a timing signal is.

A fundamental principle in relativity is the constancy of the speed of light, which states that electromagnetic signals travel in a vacuum at a unique speed in an inertial (non-rotating constant velocity) reference frame ($c = 299,792,458$ meters per second). This principle allows one to extend a network of self-consistently synchronized clocks throughout an inertial reference frame. During the first part of our century, G. Sagnac showed that in a rotating (non-inertial) reference frame, the velocity of light is not constant. As a consequence, it is not possible to establish a self-consistent system of synchronized clocks over the earth’s surface simply assuming constancy of c as viewed from our rotating earth. Instead it is useful to imagine a reference frame with origin at the earth’s center but which is not rotating — a so-called Earth-Centered Inertial (ECI) frame. Earth spins once per sidereal day with respect to this ECI frame. Hypothetical clocks at rest in this frame can be self-consistently synchronized and syntonized using constancy of c . However, clocks in satellites or at rest on the earth’s surface are in motion through this ECI frame and move through Earth’s gravitational potential. Therefore corrections to atomic clock readings must be made to compensate for motional and gravitational effects so that real clocks read the same time as the hypothetical clocks that are at rest in the underlying ECI frame. This results in a time called “coordinate time.” GPS time is an example of such a coordinate time.

The reference for coordinate time for Earth has been given us by international conventions. In 1971 the General Conference of Weights and Measures stated that: “International Atomic Time (TAI) is the time reference coordinate established by the Bureau International de l’Heure on the basis of the readings of atomic clocks operating in various establishments in accordance with the definition of the second, the unit of time of the International System of Units.” In 1988, the responsibility for TAI was transferred to the Time Section of the Bureau International des Poids et Mesures, BIPM. In 1980, the Comité Consultatif pour la Définition de la Seconde, (CCDS) declared: “TAI is a coordinate time scale defined in a geocentric reference frame (origin of the frame at the centre of the Earth) with the SI second as realized on the rotating geoid as the scale unit.” Here SI stands for the International System of Units.

Earth has the shape of an oblate spheroid due to centrifugal force as it spins. Its average equatorial radius is larger than its polar radius by 21,476 meters. The geoid mentioned above is that surface where the total effective gravitational potential is the same, which nominally follows this oblate shape and is approximately the same as sea level. Ideal clocks at rest anywhere on the rotating geoid will tick at the same rate. The SI second as currently given by the cesium atom adjusted to the rotating geoid defines the second for TAI. Since all primary frequency standards laboratories are actually above the geoid, a correc-

tion has to be applied for the height at which each of these standards rests. The primary frequency standard for the U.S., NIST-7, in Boulder, Colorado runs fast with respect to an ideal clock at the geoid by about 1.8×10^{-13} , which is very significant given its current accuracy of 0.05×10^{-13} . The size of the effect is about 1×10^{-13} per kilometer of elevation above the geoid.

For a clock fixed on Earth at distance r from the earth's center and at geocentric latitude θ , the fractional frequency shift is

$$\Delta v/v = \left[V(r, \theta) - \Omega_E^2 r^2 \cos^2 \theta / 2 - \left(V(a_1, 0) - \Omega_E^2 a_1^2 / 2 \right) \right] / c^2$$

where $V(r, \theta)$ is the earth's gravitational potential including quadrupole and perhaps higher multipole moment contributions, Ω_E is Earth's angular rotation rate (one cycle per sidereal day), and a_1 is Earth's equatorial radius. The terms proportional to Ω_E^2 arise because of the spin of the earth. They can be thought of as contributions to the effective gravitational potential in the rotating frame. Since clocks at rest anywhere on the geoid tick at the same rate, it is convenient to evaluate the last correction term along with the true gravitational potential $V(a_1, 0)$ at the earth's equator. If the earth-fixed clock is at height h above the geoid, the combination of terms gives a fractional frequency shift of approximately gh/c^2 where g is the measured value of the acceleration of gravity.

For a clock moving with velocity v through the ECI frame the term $\frac{1}{2} \Omega_E^2 r^2 \cos^2 \theta$ must be replaced by $\frac{1}{2} v^2$. Einstein's second-order Doppler correction states that a clock moving at a velocity "v" with respect to an inertial frame will appear to run slow when compared with synchronized clocks in the inertial frame by a fractional amount " $v^2 / (2c^2)$ ". This is the reason for the second and fourth terms in the above correction equation. For clocks in GPS orbits, the second-order Doppler corrections cause the clocks to run slow by 0.823×10^{-10} with respect to clocks at the geoid. On the other hand, the purely gravitational frequency shifts cause GPS satellite clocks to run fast with respect to clocks at the geoid by 5.289×10^{-10} . The sum of these two effects is 4.46×10^{-10} . GPS satellite clocks are slowed by this amount before launch in order for the broadcast signals to be correct when used anywhere near the earth.

Since the GPS orbits are not perfectly circular, the eccentricity of each satellite's orbit is broadcast in its data message. The GPS receiver software has to calculate the additional relativistic effects due to this eccentricity. The magnitude of this effect can be several dozens of nanoseconds for GPS orbits. The eccentricities of Russia's equivalent system to GPS, called GLONASS, tend to be much smaller than for GPS. It appears that the very small eccentricity effect in the GLONASS system is accounted for at the transmitters by modulation of the transmitted clock coefficients. GLONASS was designed so that the receivers can get by without having to calculate this relativistic effect.

Clocks being compared at different longitudes on Earth's surface have to include the relativistic Sagnac effect due to the rotation of the earth. The size of the effect is given by $2\Omega_E A_p / c^2 = A_p \times 1.6227$ nanoseconds per square megameter (Mm^2) where Ω_E is the angular velocity of the earth. A_p is the total area, projected on Earth's equatorial plane, mapped out by the radius vector from the center of the earth to the portable clock or to the electromagnetic signal carrying the time. The correction is positive going eastward. In other words, if a perfect portable clock were transported eastward around the globe on the geoid, so slowly that its velocity relative to the ground didn't matter, then when it returned to its starting point, 207.4 nanoseconds would have to be added to its reading for it to agree with its reading if it had been left at the point of departure. The circumference of Earth is about 40 Mm — giving it a cross sectional area of 127.8 Mm^2 at the equator ($127.8 \times 1.6227 = 207.4 \text{ ns}$). For receivers at known locations such as timing centers, when GPS time is transferred by a signal from satellite to ground, the Sagnac effect has to be programmed into the receiver in order to estimate the projected area of the triangle having corners at the GPS satellite sending the signal, the receiver's location, and the center of the earth.

The question arises, “what about the effects due to the moon and the sun and the fact that Earth is not in a circular orbit?” These effects are well understood. The reference frame of choice for relativistic corrections on and about the earth is a non-rotating Earth-centered frame — an ECI frame. Fortunately, since our ECI frame is in free fall about the sun, Einstein's Principle of Equivalence implies that for near-earth clocks relativistic corrections as viewed from our ECI frame remain the same over the course of a year at very high levels of accuracy. This self consistency holds for clocks being compared in the vicinity of the earth [22, 23, 24]. As soon as timing measurements are made outside our Earth-Moon system, other coordinate systems and relativistic considerations enter in.

How to Access UTC

Since UTC is not directly available as a clock, real-time approximations to it are made available from 50 timing centers around the world. A list of the timing centers generating a UTC(k) time scale is provided in Table 4 as taken from the BIPM annual report. Most of the UTC(k)s are kept within one microsecond of UTC. A good percentage of them keep within 100 nanoseconds of UTC, and a few of them are usually within 10 ns of UTC.

As UTC continues to improve in its stability, and as the different UTC(k) time scales also become more stable, the errors in predicting UTC will continue to get smaller. One of the biggest problems in accessing UTC is not the accuracy of the source but rather the instabilities in the time and frequency transfer techniques.

Table 4. Acronyms and Locations of the Timing Centers Which Maintain a Local Approximation of UTC, UTC(k), or/and an Independent Local Time Scale, TA(k)

AOS	Astronomiczne Obserwatorium Szerokosciowe, Borowiec, Polska
APL	Applied Physics Laboratory, Laurel, MA, USA
AUS	Consortium of laboratories in Australia
BEV	Bundesamt für Eich - und Vermessungswesen, Wein, Oesterreich
BIRM	Beijing Institute of Radio Metrology and Measurement, Beijing, P.R. China
CAO	Cagliari Astronomical Observatory, Cagliari, Italia
CH	Consortium of laboratories in Switzerland
CNM	Centro Nacional de Metrologia, Queretaro, Mexico
CRL	Communications Research Laboratory, Tokyo, Japan
CSAO	Shaanxi Astronomical Observatory, Lintong, P.R. China
CSIR	Council for Scientific and Industrial Research, Pretoria, South Africa
F	Commission Nationale de l'Heure, Paris, France
DLR	Deutsch Forschungsanstalt fuer Luft-und Raumfahrt, Oberpfaffenhofen, Germany
DTAG	(Formerly FTZ) Deutsch Telecom AG, Darmstadt, Deutschland
GUM	Główny Urząd Miar, Central Office of Measures, Warszawa, Polska
IEN	Istituto Elettrotecnico Nazionale Galileo Ferraris, Torino, Italia
IFAG	Institut für Angewandte Geodäsie, Frankfurt am Main, Deutschland
IGMA	Instituto Geografico Militar, Buenos-Aires, Argentina
INPL	National Physical Laboratory, Jerusalem, Israel
IPO	Instituto Português da Qualidade (Portuguese Institute for Quality), Monte de Caparica, Portugal
JATC	Joint Atomic Time Commission, Lintong, P.R. China
KRIS	Korea Research Institute of Standards and Science, Taejeon, Rep. of Korea
LDS	The University of Leeds, Leeds, United Kingdom
MSL	Measurement Standards Laboratory, Lower Hutt, New Zealand
NAOM	National Astronomical Observatory, Misuzawa, Japan
NAOT	National Astronomical Observatory, Tokyo, Japan
NIM	National Institute of Metrology, Beijing, P.R. China
NIST	National Institute of Standards and Technology, Boulder, CO, USA
NPL	National Physical Laboratory, Teddington, United Kingdom
NPLI	National Physical Laboratory, New-Delhi, India
NRC	National Research Council of Canada, Ottawa, Canada
NRLM	National Research Laboratory of Metrology, Tsukuba, Japan
OMH	Országos Mérésügyi Hivatal, Budapest, Hungary
ONBA	Observatorio Naval, Buenos-Aires, Argentina
ONRJ	Observatorio Nacional, Rio de Janeiro, Brazil
OP	Observatoire de Paris, Paris, France
ORB	Observatoire Royal de Belgique, Bruxelles, Belgique
PTB	Physikalisch-Technische Bundesanstalt, Braunschweig, Duetschland
RC	Comité Estatal de Normalizacion, Habana, Cuba
ROA	Real Instituto y Observatorio de la Armada, San Fernando, Espana
SCL	Standards and Calibration Laboratory, Hong Kong
SNT*	Swedish National Time and Frequency Laboratory, Stockholm, Sweden
SO	Shanghai Observatory, Shanghai, P.R. China

Table 4. (continued)

SU	Institute of Metrology for Time and Space (IMVP), NPO "VNIIFTRI" Mendeleev, Moscow Region, Russia
TL	Telecommunication Laboratories, Chung-Li, Taiwan
TP	Institute of Radio Engineering and Electronics, Academy of Sciences of Czech Republic-Czech Republic
TUG	Technische Universität, Graz, Oesterreich
UME	Ulusal Metroloji Enstitüsü, Marmara Research Centre, National Metrology Institute, Gebze-Kocaeli, Turkey
USNO	U.S. Naval Observatory, Washington, D.C., USA
VSL	Van Swinden Laboratorium, Delft, Nederland
*	SNT ceased its time activities in May 1995.

Figure 13 shows how long an averaging time is needed to obtain a certain level of stability and traceability via a given time and frequency transfer technique. If the limiting transfer or distribution noise is white-noise PM, then $\text{Mod.}\sigma_y(\tau)$ was used to show both the kind and level of noise. In this case notice that the slope is proportional to $\tau^{-3/2}$, and for a normal distribution of errors, the 68 percent uncertainty on frequency transfer or distribution accuracy is given by $2 \times \text{Mod.}\sigma_y(\tau)$. As mentioned in the beginning of this article, frequency stability is a measure of the change of the frequency from one period of time to the next. The length of this period of time is called the averaging time, τ . A particular value of τ is chosen, and then the frequency stability is ascertained over a data set for a given method of time and frequency dissemination or transfer. Notice that essentially all techniques improve with increased averaging time.

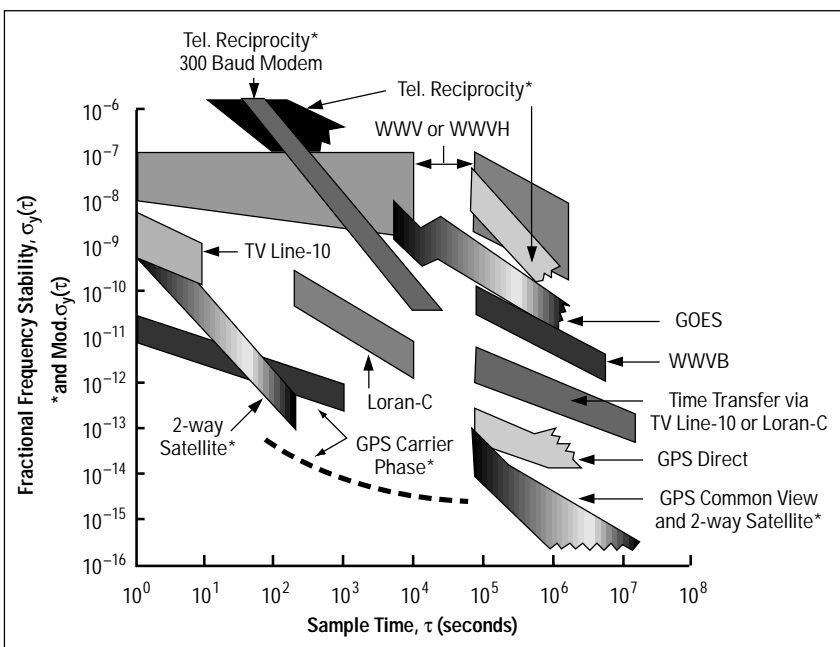

Figure 13. A plot of the frequency instabilities of traditional means of transferring or distributing frequency. Dashed line shows experimentally verified potential for GPS Carrier Phase technique. Telephone Reciprocity with 300 Baud Modem was a special experiment within a calling area and staying "on hook" for several hours.

State-of-the-art techniques are used to communicate the time and frequency data to the BIPM for the calculation of UTC. With the frequency stability of clocks continually improving, the short-term instabilities of the transfer techniques have increasingly become a problem and limit the short-term instabilities achievable for UTC. The initial flat portion of the UTC curve in Figure 12 is due to the instabilities of the time transfer technique. Figure 14 gives the time stability of some state-of-the-art time transfer techniques.

The principal operational means of communicating the times of the contributing clocks to the BIPM is the GPS common-view technique which may be explained by the following example. This technique has been automatically designed into special GPS timing receivers [13]. Suppose, for example, the time of a clock in Boulder, Colorado is being communicated to the Paris Observatory. At a predetermined time (preset in software) the clock in Boulder measures its time difference with respect to GPS time, $B - G$. At the same time the GPS receiver in Paris, listening to the same satellite, measures its time difference with respect to GPS time, $P - G$. The GPS signal for the same satellite is averaged over the same 13-minute time window, then these measurements are exchanged and subtracted, yielding $B - P$ time difference. With all the delay corrections properly accounted for, the accuracy of this technique has been shown to be a few nanoseconds. Notice that the effects of SA drop out in the subtraction to the extent that SA is due to satellite clock dither, as do many other common-mode errors. Even though the GPS common-view technique presently limits the short-term stability of UTC, it improved the accuracy and stability of time-transfer by more than a factor of 20 when it was introduced in the early 1980s. Loran-C had provided the best operational time-transfer technique prior to GPS.

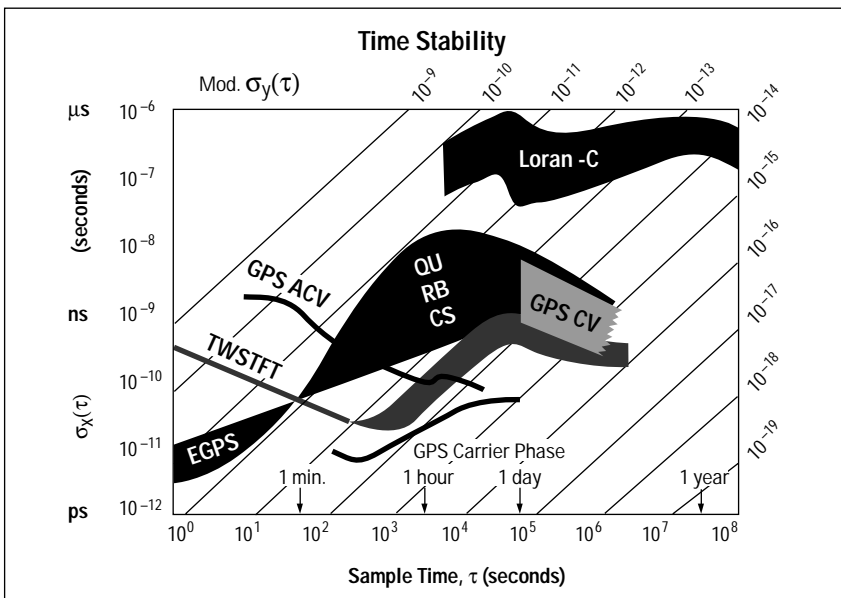

Figure 14. A plot of the time stability of some of the state-of-the-art time transfer techniques as compared with some of the more traditional techniques.

In recent years, there has been a rapid increase in the use of GPS as a source of UTC. With minimal effort and little cost, one-microsecond accuracies are readily achieved. There are many applications, however, where much better timing is needed, and most of these situations need a real-time output, such as for telecommunications or the power grid. However, the degradation in the GPS signal caused by SA can cause some hundreds of nanoseconds peak-to-peak variations. The current GPS common-view technique, which avoids the SA degradation to a large extent, only gives time differences between two clocks after the fact.

A novel approach was developed a few years ago in which the nature of the instabilities of SA was studied [15]. Understanding the character of these instabilities as compared with the very different character of the instabilities in precision clocks allowed real-time filters to be designed for timing receivers in fixed locations. Using, for example, the HP 5071A cesium-beam clock with an appropriate filter design essentially eliminates the SA in real-time. If clocks using quartz crystal oscillators or rubidium gas-cell frequency standards are used instead, a good level of SA filtering is still achievable. The clock using rubidium offers better filtering than one using a quartz-crystal oscillator, but the latter can be built more cost-effectively and with better reliability. Products based on these SA filtering concepts have become very popular and useful for precision network timing. Figure 14 illustrates the time stability achievable using these SA filtering concepts as compared with some other precision timing techniques. They are denoted as the Enhanced (EGPS) technique.

ACV denotes Advanced Common-View technique. The ACV technique utilizes the degrees of freedom available from the newer GPS timing receivers. These include the one-second data, the several satellites one can always observe at a given site, and the convenient methods now available for exchanging data rapidly. In contrast, the original common-view (CV) approach only uses one satellite at a time over 13-minute averages and is based on a one-day average, post analysis. A simple degrees-of-freedom argument shows more than a factor of 50 advantage of the ACV technique over the CV technique; however, the research and development are far enough along on the ACV technique to determine that there are correlations in the data that take away some of these degrees of freedom. Still the actual performance obtained is very encouraging. It has the potential to provide short-term performance in real-time and could be made fully automatic. It cancels the SA degradation to a large extent. Hardware and software development compatible with the experimental results is still needed.

TWSTFT denotes Two-Way Satellite Time and Frequency Transfer technique. It exhibits excellent short-term stability — limited by only two or three hundred picoseconds of white-noise PM taken over one-second averages. However, the environmental effects on the transmit and receive equipment cause the slope upward and the degradation in the longer-term performance. Improvements are being worked on and are expected for TWSTFT.

Future Timing Techniques

EGPS denotes the Enhanced GPS technique. It is a systems approach in which the attributes of the reference clock are best utilized to filter the effects of the GPS SA degradation in order to obtain a real-time estimate of UTC. Note that different levels of filtering are obtained depending on whether the reference clock uses a quartz-crystal oscillator (QU), a rubidium gas-cell frequency standard (RB), or cesium-beam frequency standard (CS). The CV denotes the traditional GPS Common-View technique, which is used to transfer the times and frequencies of most of the standards contributing in the generation of TAI and UTC. It removes the effects of SA to a large extent and employs one-day averages — providing an after-the-fact solution. Data acquisition is fully automatic. Improvements are anticipated by improving GPS receiver stabilities and accuracies and by better characterization of atmospheric delays. Both GPS CV and GPS ACV use the broadcast time code. Using instead the phase of the GPS carrier frequency for transferring time and frequency information between two sites remote to each other shows significant promise, but it is still in the research phase. The results plotted are between hydrogen maser clocks located in Goldstone, California and Algonquin Park, Canada separated by four megameters (4,000 km or 2,500 miles). Loran-C has been the principal means for navigation for several decades. Even though it is used for timing, the signal is not self-contained in that time-of-day information is not available and another source, such as WWV, is needed to resolve the time ambiguity. The carrier signal is at 100 kHz (10 microsecond period). For Figure 14, the ordinate is the time stability, the abscissa is the amount of averaging time used in measuring the change with adjacent averaging periods. Also shown are the decade values for $\text{Mod.}\sigma_y(\tau)$ in order to have a measure on the same graph of the uncertainty in frequency transfer accuracy.

A current International Telecommunications Union (ITU-R) handbook, entitled “Selection and Use of Precise Frequency and Time Systems,” contains a set of tables summarizing the various techniques for time and frequency distribution and for comparison of clocks remotely located from each other. By permission, these tables are included in Appendix C.

T2L2 (Time Transfer by Laser Link) is a dedicated time-transfer experiment under development at the Observatoire de la Côte d’Azur and the *Centre National d’Etudes Spatiales* in France [25]. T2L2 is designed to synchronize remote clocks with precision on a single measurement of 50 picoseconds and an accuracy in the 50 picoseconds region. Such performances have never been reached and have many technological (navigation, telecommunication, positioning) and scientific (gravitation, solar quadrupole momentum) applications. The principle of this time-transfer technique is based on the propagation of light pulses between the clocks for synchronization, as in the Laser Synchronization from Stationary Orbit (LASSO) experiment, but without external calibration. LASSO has been successfully tested in

1992 between McDonald (Texas) and Grasse (France), with a stability of 100 picoseconds and an accuracy on the order of 1 nanosecond. The light pulses carry the temporal information from one clock to another. A clock on board a satellite is used as a relay between Earth clocks to allow time transfer between remote clocks. One could also use the technique to place a reference clock on the satellite and use the optical time-transfer to synchronize the Earth clocks to this reference.

The usual time-transfer techniques are based on the propagation of a wave in the microwave domain: GPS Common-View and Two-Way Satellite Time- and Frequency-Transfer. The interaction between the radio-frequency signal and the atmosphere presently does not allow an accuracy much better than 1 nanosecond with an ultimate value estimated as around 100 picoseconds. The optical wave propagation is well controlled, and it is for this reason that the optical time-transfer technique achieves such accuracy and precision. The transmission path delay can be calibrated much more accurately than that for microwave signals. Unfortunately, it is weather-dependent — clouds will block the path.

To perform a T2L2 time-transfer, laser stations and a satellite are needed, both equipped with a clock and time-tagging unit. The T2L2 experiment allows the monitoring of the space clock from a ground clock and the transfer of time between the ground clocks via the satellite clock. The laser stations emit some light pulses in the direction of the satellite. An array of retroreflectors returns a fraction of the received photons to the stations (the photons are returned along the same direction). The stations record the start times of the light pulses and the return times after reflection from the satellite. The satellite time-tagging unit measures the onboard arrival time of the pulses. Then, for a given light pulse emitted from station A, the offset X_A between clock A and the satellite clock can be computed. For another light pulse emitted from station B, the offset X_B can also be computed. The time-transfer between the clocks A and B is deduced from the difference in the offsets X_A and X_B . Station and satellite data are

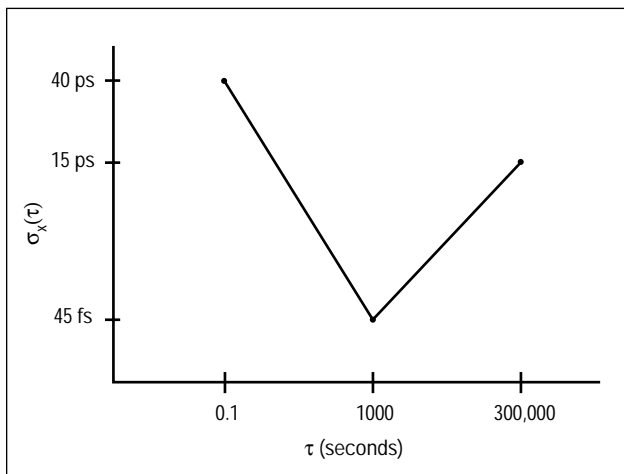

Figure 15. Time-transfer stability between a ground clock and the satellite clock for T2L2.

regularly transmitted to the T2L2 coordination center for analysis. The accuracy of the time-transfer between the satellite clock and the ground clock integrated over ten days is estimated at 50 picoseconds, considering that the ground and satellite contributions are equal. This implies that the frequencies of the ground clock and the satellite clock can be compared with an accuracy in the range of 6×10^{-17} . However, it must be stressed that the time origin at the satellite is arbitrary, so it is not possible to know the phase between the ground clock signal and the satellite clock signal.

Plans are in hand to test the next generation of atomic clocks and time-transfer techniques in space. Scheduled for launch around 2003, Atomic Clock Ensemble in Space (ACES) is a multi-Agency proposal between the United States, the Russian Federation, Japan, Europe and Canada to fly an ensemble of the next generation of atomic clocks onboard the International Space Station Alpha. ACES would consist of an ensemble of externally-mounted payloads. In the benign, microgravity environment of space, the fractional frequency stability and accuracy attainable should be in the range of 10^{-16} to 10^{-17} .

None of the next generation of atomic clocks has flown in space to date, with the exception of the hydrogen maser in 1976 on board the Scout Rocket during the two-hour red-shift experiment for the Gravity Probe A mission [22]. Future atomic clocks (active-cavity hydrogen maser, cesium atomic fountain, mercury linear ion-trap) are all capable of ground-based frequency stabilities of 10^{-15} (or better) above 10,000 seconds averaging time. In a microgravity environment, there is no fundamental reason why the hydrogen maser or trapped-ion clocks should perform better in space. But, the cesium fountain would outperform its counterparts through an increased interaction time between the atoms and the cavity microwave field. Local oscillators, such as the BVA quartz crystal oscillator and the composite dielectric resonator, would complement these new atomic clocks for short-term averaging times and would have an important role to play.

ACES would allow the characterization and comparison of three different ultra-stable clocks in space. The concepts of these clocks are quite different: the maser is an active-cavity system, the fountain uses laser-cooling techniques, and the ion-trap is based on electromagnetic trapping of charged particles.

Two-way satellite time- and frequency-transfer through microwave (TWSTFT) and optical (T2L2) links will provide a unique high-performance flying timing-laboratory in space, based on the space atomic clocks, and would be available on a global basis. Current capabilities with the atmosphere-independent microwave link is at the sub-nanosecond level. The optical link appears to permit clock comparison at the sub-picosecond level, essential to test the stability of the space-based atomic clocks now being constructed.

ACES will become an essential Time and Frequency research platform. The applications are immense and include:

1. Tests of fundamental physics with Relativity tests of unprecedented precision (Einstein Principle of Equivalence, the Shapiro delay, the isotropy of light, the search for the variation of the fundamental constants)
2. Very Long Baseline Interferometry
3. High-precision geodesy and Earth spin rate dynamics
4. Study of the atmospheric propagation of light pulses and microwave signals
5. Time and frequency comparison with ground-based clocks more than 2 orders of magnitude over GPS
6. Establishing a global time dissemination system from space

ACES would also be the first step towards testing of atomic clocks in space prior to their commercialization. This would be of great benefit for:

1. Telecommunication network synchronization for digital broadcasting and global mobile communications
2. Navigation and positioning in the vicinity of Earth and in deep space

Atomic clock development with ACES could greatly benefit the development of the next-generation of Global Navigation Satellite Systems (GNSS), with the potential for orders of magnitude improvement over existing GPS and GLONASS systems [26].

Global Navigation Satellite System Developments

Because so many of us fly, airline safety is a key issue. Navigation and timing for all of avionics have taken a giant step forward with the availability of GPS. Since aircraft navigation and timing go hand-in-hand, this section is intended to provide an appreciation for some of the exciting developments that are being planned. The Global Navigation Satellite System (GNSS) is a major international coordinated initiative to provide a seamless global navigation and positioning system by satellite that meets civilian users' requirements in a cost-effective way. Precise and accurate timing —including UTC — are built into the designs, and atomic clocks are at the heart of its success. A set of geostationary satellites will be used to augment the signals already available from GPS and GLONASS. These satellites are being sponsored through international cooperation by the International Maritime Satellite Organization (INMARSAT). Developments are well in hand.

The USA plans to provide a second frequency for civilian use on the Block 2F GPS satellites. This signal would provide civil users an accurate measurement of the GPS signal through the ionosphere — now one of the biggest uncertainties in precision airline navigation.

Improvements in satellite position prediction and clock accuracy are in progress. Inter-satellite links are being implemented with the GPS Block 2R program that should already increase the time and position accuracy available from GPS. The Block 2R satellites are scheduled for launch starting 1997.

The Federal Aviation Administration (FAA) is in the process of developing and implementing a GPS Wide-Area Augmentation System (WAAS) for all U.S. air traffic. The WAAS program could bring about large fuel savings, increased inflight safety, and all-weather precision landings. The ultimate goal of this program for precision landings is 0.8 meters (about 2¹/₂ feet) [27].

A similar augmentation is being implemented in Europe. The European Geostationary Navigation Overlay Service (EGNOS) will augment the existing GPS and GLONASS, improving the accuracy, integrity, availability and continuity that is currently attainable. Sometimes termed GNSS1, the first-generation Global Navigation Satellite System, EGNOS will support five levels of service over different service areas. EGNOS is designed to provide the best performance over Europe, while at the same time guaranteeing a minimum level of service at any location where Geostationary signals can be received. Initial operation is expected in 1999 for levels 1, 2 and 3, with full operation scheduled for 2002 on all five levels.

The Russian authorities appear to be committed to making GLONASS available for civil aviation and acceptable to the international community. A study is under way to identify options for cooperation between Western Europe and Russian industry in the field of GLONASS and other related navigation systems.

In addition to being a provider of GNSS services at the international level with WAAS and EGNOS, INMARSAT is also proposing to add a dual-frequency navigation function to its Intermediate Circular Orbit (ICO) communications satellites which are due to be launched around the period 1999-2000. The proposed system, the International Satellite Navigation Service (ISNS), would provide both an overlay service and an independent dual-frequency navigation signal, which will improve the accuracy in accounting for the timing signal's propagation delay. ISNS is expected to be capable of providing non-precision approach capability worldwide without differential ground augmentation.

The Japanese Space Agency (NASDA) plans to launch two geostationary satellites to provide relay of navigation, integrity, ranging and differential messages to users in the Asia Pacific region. The service will mainly cover the Pacific Ocean region which is at present poorly served by the INMARSAT-3 overlay system. The satellites, which are already in the development stage, will provide communications and weather capabilities to users in the region. The initial Multi-functional

Transport Satellite (MTSAT) launch is scheduled for 1999, with a replacement satellite in 2005. MTSAT alone will not meet requirements for primary means of navigation, but it will probably provide a component to the future Asian region wide-area system. The Indonesian government is also currently planning to launch two additional Geostationary satellites with navigation payloads to complement MTSAT in the South-Eastern Asia region. The first satellite is expected to be launched in 2000.

Institutional and cost constraints mean that Europe is unlikely to unilaterally launch its own satellite system to provide a service on a global basis. Instead, European organizations are concentrating their efforts on developing a European contribution to GNSS. The European Space Agency is leading the developments in this area and has issued a number of concurrent studies.

The European Space Agency (ESA) has made significant progress in its development of the wholly-civil GNSS2. Following an initial GNSS2 Mission Analysis study of system architectures in 1995, ESA is now concentrating on the key technical issues such as satellite orbit configurations. The program is aimed at early demonstration of a flight experiment by 1999, although an increase in Member State contributions to the GNSS2 program could mean seeing this time scale reduced. This ambitious project is expected to be funded through public-private initiatives. Both the European Space Agency and the European Commission are giving their full backing to the program, indicating its importance towards the future competitiveness of European industry. It remains that Europe is keen to see implementation of a developmental system as soon as possible. GNSS2 is expected to achieve full operation around 2007-2010 and remain operational until at least the year 2025.

European organizations are currently concentrating their efforts on developing a European contribution to GNSS: the regional European Navigation Satellite System (ENSS). The ESA is leading the developments in this area and has issued a number of concurrent studies to examine the ENSS functional definition. One possible constellation studied comprised twelve Inclined Geosynchronous Orbit (IGSO) satellites and up to three Geostationary (GEO) satellites. This would provide a vertical accuracy of better than 6 meters and provide continuous coverage for civil aviation. Following this study, the European Commission has moved another step forward. Edith Cresson, the European Commissioner for Science, Research and Development (DG XII), has given her support to European moves to break into the satellite navigation market, backing proposals for a billion-ECU program (\$1.1 billion U.S.) to develop a regional ENSS. It is hoped that this move will allow European industry to share in a booming market where the core technology is currently controlled by the United States and the Russian Federation.

Ultimately, the decision to fabricate the next-generation GNSS will be taken at the political and institutional levels. Who needs it? Who will pay for it? Only through international cooperation and coordination can there be a truly seamless, international, next-generation GNSS. The European Space Agency is currently engaged in discussions with the Russians, Japanese and Americans to ensure that there is a common goal and to minimize the duplication of effort. The cost of providing such a system would be prohibitive without the cooperation of all partners.

Currently, for example, GPS and GLONASS are not synchronized and use very different coordinate reference frames [28]. One of the major differences between GPS and GLONASS is that they use different references for time and space. For time reference, GPS relies for its GPS Time on UTC(USNO MC), Coordinated Universal Time (UTC) as realized by the USNO. GLONASS relies for its GLONASS Time on UTC(SU), UTC as realized by the Russian Federation. UTC is produced by the BIPM and is the internationally recognized time reference for the whole Earth.

In the past UTC(SU) and GLONASS time have been off several microseconds from UTC. UTC(USNO MC) has kept very close synchronization to UTC — within 20 ns. At the 13th Session of the CCDS (Comite Consultatif pour la Definition de la Seconde) held on 12-13 March 1996, it was recommended (Recommendation S4 (1996)):

- that the reference times (modulo 1 second) of satellite navigation systems with global coverage (such as Global Positioning System (GPS), Global Navigation Satellite System (GLONASS), International Maritime Satellite Organization (INMARSAT), Global Navigation Satellite System 1 (GNSS1), Global Navigation Satellite System 2 (GNSS2)) be synchronized as closely as possible to UTC,
- that the reference frames for these systems be transformed to be in conformity with the terrestrial reference frame maintained by the International Earth Rotation Service (ITRF),
- that both GPS and GLONASS receivers be used at timing centers.”

Following this Recommendation the Russian Federation agreed to improve synchronization of its time scales with UTC. This will become an important factor for one-way time-dissemination for GNSS1 where the timescales for the three systems will need to be coordinated. There is also the additional problem that GLONASS includes leap seconds and GPS does not — making the time difference, as of July 1997, 12 seconds on top of the difference between UTC(SU) and UTC(USNO MC).

Currently, the GPS coordinate reference frame complies well within a meter of the International Terrestrial Reference Frame (ITRF). From the last report of the Russian authorities, getting the GLONASS reference frame also to comply poses a much bigger challenge and may not happen for some time.

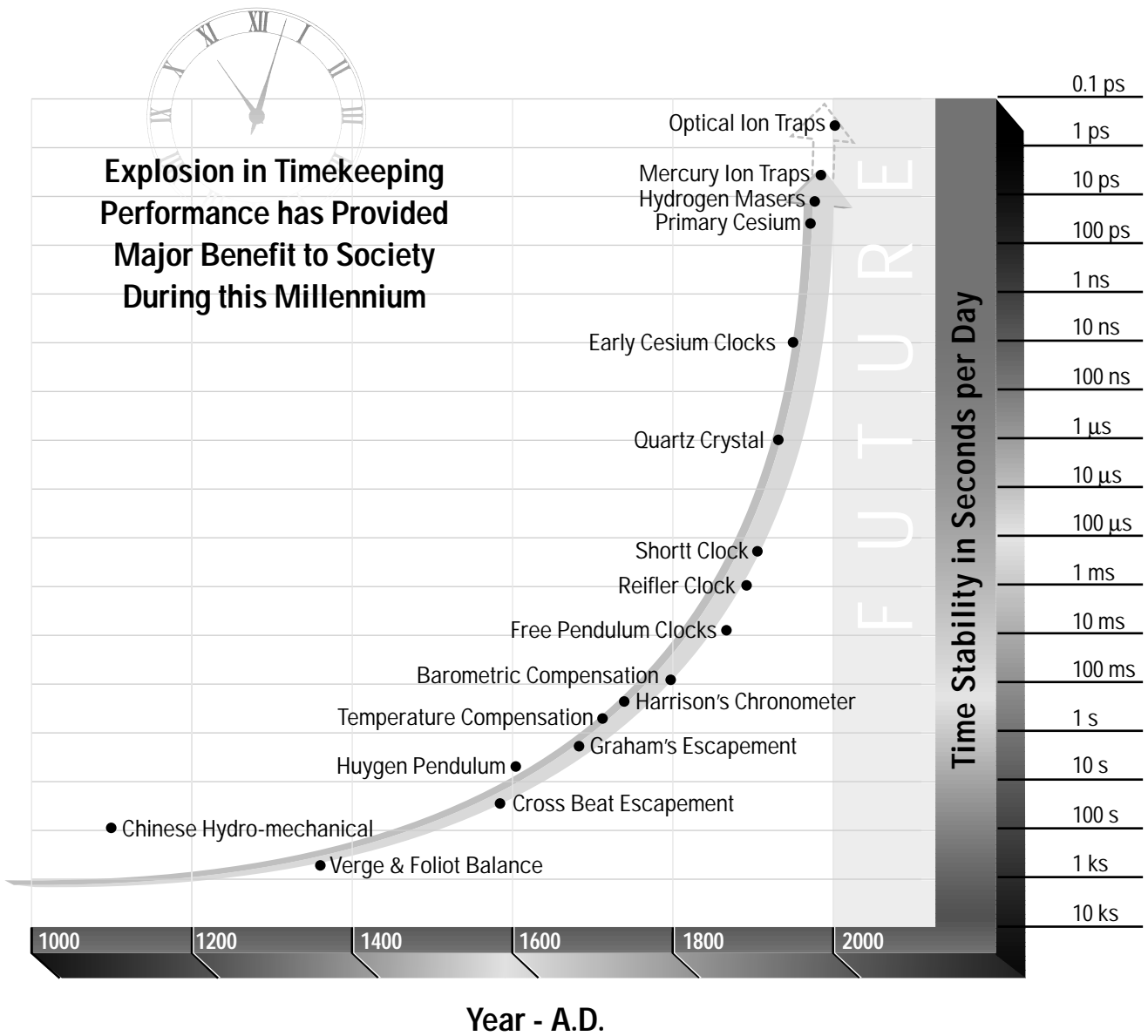

The next-generation GNSS user market will be automotive as well as avionics. The accuracy requirements will be much more stringent — 10 centimeters is one of the long-term goals. Light travels 10 cm in 1/3 nanosecond. Methods have been proposed and are being studied that could accomplish these incredible goals for navigation and for clock synchronization among a set of orbiting satellites. Propagation delay inaccuracies pose one of the biggest problems.

Finally, the issue of who controls the next-generation GNSS is complex and beyond the scope of this paper. We merely mention some of the challenges ahead. Encryption of the signal would need agreement from all parties owing to the global nature of the system. Ensuring a seamless system will be difficult. And for safety-critical applications, responsibility and liability for the operation of the system is currently an active area of research [29].

UTC and the Future

UTC is the common reference for all national time scales. The BIPM timing experts have been very responsive to the needs expressed by the nations as they have assembled under *la Convention du Mètre* as part of the Consultative Committee for the Definition of the Second (CCDS). Significant advancements have been reported by the BIPM staff on the accuracy and stability of UTC. Essentially all of the timing needs throughout the world are being satisfied through the current methods of generation and distribution. The burden for providing a real-time estimate of UTC falls on each nation. Now that GPS has international coverage, this burden is very minimal.

Currently, GPS can be used to obtain an estimate of the UTC(USNO MC) clock. If the time output of a good multi-channel Clear Access (C/A) code GPS receiver is averaged for one day against a sufficiently stable local clock, such as a cesium standard, the resulting estimate of UTC(USNO MC) will be within 20 ns 95 percent of the time. Since UTC(USNO MC) is steered to be within 20 ns of UTC at least 95 percent of the time, we can expect that the GPS broadcast correction will be within 30 ns of UTC 95 percent of the time. The frequency excursions of UTC(USNO MC) via GPS are typically below 1×10^{-13} when averaged over one day. The GPS clock ensemble has a long-term frequency stability of about 2×10^{-14} . The frequency stability of UTC(USNO MC) is about 2×10^{-15} , and its rate is a predicted-forward estimate of UTC well within the BIPM frequency uncertainty stated in the UTC bulletins of 1×10^{-14} .

As the second used in the generation of UTC is continually steered toward the best estimate of the SI second given by the primary frequency standards, we have seen, and it is anticipated we will continue to see, significant improvement in the accuracy of the UTC second as a result of the continued improvement of the SI second generated by the primary standards. Primary standards are being constructed now with anticipated accuracies of 1×10^{-16} . These improved accuracies will benefit the precision user community within the limitations of the methods of communicating time and frequency.

As other ways to improve the usefulness of UTC are considered, there are two areas that could help: first, to make UTC a real-time service like GMT used to be; and second, to decrease the measurement noise in the time and frequency transfer, dissemination and distribution techniques.

The fact that UTC is not available in real-time means that none of the users having real-time synchronization needs can use world official time. The number of users needing real-time synchronization is increasing rapidly; hence, they have found alternative solutions for synchronizing their timing networks. The measurement noise associated with communicating time from one location to another is of such a nature that the performance of state-of-the-art clocks cannot be utilized at a distance. This measurement noise also degrades the short-term stability of UTC.

The long-term performance accuracy and stability of UTC can take advantage of the best clocks in the world and are currently doing so. This is because the measurement noise can be averaged away over a long enough time. The problem is that as clocks continue to improve, the amount of time needed to average away the measurement noise is getting longer and longer.

Thus there is a need for both real-time access to UTC and improved methods of communicating time and frequency between clocks and to the user community. Both problems are being addressed by the international time and frequency metrology community, and solutions will undoubtedly be forthcoming. Neither problem is insurmountable. As clocks improve and as methods for communicating time and frequency improve, the resulting available accuracies will also improve.

Conclusions

We have seen how precise timing has provided significant benefit to society, and we anticipate an increase in its contribution. The basic reference for timing is UTC. The time and frequency input to UTC comes from timing centers around the globe. Most national timing centers generate real-time estimates of UTC that are used for consumption in their respective countries. Since atomic clocks were invented a half century ago, we have witnessed a factor of a million improvement. These improvements have been in both the quantity and the quality of the time and frequency signals provided to the user community. Not surprisingly, the number of users has increased dramatically over the last two decades. GPS has become the lead supplier of very accurate time and frequency information, specifically for UTC as predicted by USNO [30].

In the past, many of the precise time users were content to deduce time and frequency information after the fact. An increasing number of current users need precise time in real-time with very little lapse in real-time processing of the data to deduce a current best estimate of UTC or some timing signal. Although UTC is now only available more than a month after the fact, there are numerous predicted estimates of UTC, available in real-time, to satisfy most of the user community. There is some pressure to make world official time, UTC, available in real-time. This is under study and is possible; reasonable solutions have been proposed.

Much of the information in this note may be found, in greater detail, in three sources: the ITU Handbook, The Selection and Use of Precise Frequency and Time Systems; NIST Technical Note 1337, Characterization of Clocks and Oscillators; and the BIPM Annual Report. The proceedings of four conferences contain a large number of papers with relevant material to this article: IEEE International Frequency Control Symposium; European Frequency and Time Forum; Conference on Precision Electromagnetic Measurements; and Precise Time and Time Interval Planning and Applications Meeting.

Because time and frequency can be measured more accurately than any other quantity, and because it can be measured with cost-effective equipment, time and frequency techniques in various forms are permeating many of society's activities. One of the main tools used in many of these applications is GPS; it is becoming a commonly known system. The official provider of time for GPS is ultimately UTC. We may expect the role of UTC, as the official provider of time for the world, to continue to increase in its importance along with the work of the contributing timing centers around the world. Certainly, the quality has dramatically improved in recent time as have the number of beneficiaries.

Acknowledgments

This note is an accumulation of the ideas and work of many notable contributors to the far-reaching success of precise timekeeping in modern society. We wish to take our hats off to the several who have gone before — laying the important groundwork that allows us to be where we are today. It would be too difficult to name names because of the diversity of foundational activities that bring us here. Our efforts have been to capture some of the historical perspective, highlight where we are now, and anticipate where new discoveries in precision metrology and timekeeping will propel us.

We have been privileged to have excellent critical feedback on the specific contents of this note from among the outstanding clock metrologists in the world. While the authors and HP take final responsibility for the contents we are indebted to: Dr. Rob Douglas of the Canadian National Research Council, Mr. Michael King of Motorola, Inc., Dr. John Lavery, Head of the NPL Time & Frequency Services, Professor Sigfrido Leschiutta of Italian Istituto Elettronico Nazionale G. Ferrar, Dr. Wlodek Lewandowski of the Bureau International des Poids et Mesures, Dr. Dennis McCarthy, Director of the Directorate of Time of the USNO, Dr. Demetrios Matsakis, Head of the Time Service Department of the USNO, Mr. William Riley of EG&G Rubidium Products, James McAslan Steele, retired NPL timing expert, Dr. Donald Sullivan, Chief of the Time and Frequency Division, National Institute of Standards and Technology, Dr. Claudine Thomas, Head of Time Section BIPM, Dr. John Vig of US Army Research Laboratory, and Dr. Gernot M. P. Winkler, former Director of USNO Time Services. Dr. Leonard Cutler and Robin Giffard of Hewlett-Packard Laboratories, and Jack Kusters of Hewlett-Packard (Santa Clara Division) have provided very valuable editorial and technical assistance. Mr. Sterling

Allan has also provided very valuable editorial assistance. Mrs. Sylvia Chantler and the NPL library staff have been most helpful in researching questions. The sponsorship of Hewlett-Packard (SCD) and the assistance of their editorial staff have been the mainstay to the project.

We are also particularly indebted to Dr. Philip M. Woodward, co-author of the book *The Science of Clocks and Watches*, and author of *My Own Right Time*, and Jonathan Betts, Curator of Horology, National Maritime Museum, for providing the data for the two historic chronometers we analyzed in detail in Appendix B: Kendall No. 1 and Mudge No. 1 Chronometers. These data were an important basis for one of the key figures in the text, Figure 12. William J. Riley of EG&G provided the software used in performing the statistical analysis on these chronometers, and he assisted with great interest in many other ways. This is the same statistical package used to assure that the next generation atomic clocks on board the GPS satellites (GPS Block 2R) meet performance specification. We wish to express appreciation to Dr. Robert F. C. Vessot for providing most of the data for the explosion chart on page 51.

We have received encouragement and ideas from numerous other colleagues, to whom we would also like to express appreciation. Clearly, the text pulls together a lot of disciplines, and without the wide support we have received, our task would have been, perhaps, overwhelming.

Appendix A

Time and Frequency Measures Accuracy, Error, Precision, Predictability, Stability, and Uncertainty

(See references [30] through [35] for additional details regarding the contents of this appendix.)

Example for Illustration:

Consider the flip of a coin, for illustrative purposes, which turns out to be very much like the random errors in an ideal atomic clock: heads and tails are equally probable. Consider now a million people standing in an east-west row, but all facing north — each with a coin. Each person flips his coin 100 times. If the coin comes up heads, the person takes one step north; if tails, one step backward (south). After a hundred flips of the coins, we can look down the row of people and look at the number standing at different distances from the original line. Plotting the density of people at different steps away from the origin will make a bell shaped curve approaching a normal or Gaussian distribution with a maximum at the origin. In other words, more people will have returned to where they started than to any other position. We can compute the average distance away from the origin taken across all one million people; this is called the mean value. If we let x_i be the distance away from the origin for the i^{th} person, then the mean value is computed by adding up all the x_i distances and dividing that sum by a million.

The standard deviation, σ , is obtained by subtracting from each person's distance the mean value; squaring the result; then adding up all of the squared values, dividing that sum by the number of data points minus one (999,999 values in our example); then, finally taking the square root. The minus one is used because one degree of freedom was removed in computing the mean value. In our example, σ will have the value of square root of the number of flips of the coin, $\sqrt{100} = 10$. For a normal distribution, 68 percent of the values will be within 1 σ of the origin, and 95 percent (2σ) will be within 20 steps of the origin in our example.

The standard deviation of the mean, σ_m , is given by σ / \sqrt{N} , where N is the total number of degrees of freedom. In our example, it is a million, since all the people flip coins that are totally independent of each other. In our case, $\sigma_m = 10 / \sqrt{1,000,000} = 0.01$. In other words, if this experiment were repeated over and over, 68 percent of the mean values would be within 0.01 steps of the origin.

Next, carry this analogy over to an atomic clock. Suppose each flip of the coin is the clock's effort over one second to determine the length of the SI second and it is able to do so with a standard deviation of 1×10^{-11} . Then the second to second stability would be 1×10^{-11} . The

uncertainty of the mean value of the SI second measurement after 100 seconds (100 flips of the coin) would be

$$1 \times 10^{-11} / \sqrt{100} = 1 \times 10^{-12}.$$

This is the inaccuracy of the mean value as averaged over 100 seconds.

If we had a million of these ideal clocks or a million independent 100-second measurements, then the standard deviation of these 100-second average frequencies would be 1×10^{-12} , and the standard deviation of the mean of all one million clocks or independent measurements would be $1 \times 10^{-12} / \sqrt{1,000,000} = 1 \times 10^{-15}$.

An ideal clock, like the flip of a coin, will have an error in each frequency measurement that is random and uncorrelated with any of the past errors — the coin has no memory of any of its past flips. However, since the time of a clock results from adding or integrating the frequency or rate of a clock, the time errors get integrated or added also. So like the people's distance, x_i , from the origin, the time error, x_i , for each clock adds up all of the independent frequency errors. The x_i s follow what is called a random-walk process. And even though it is random, the time error at any point in time correlates with the past because it is an accumulation of all of the past errors. We can never know the exact amount of these errors because there is no perfect reference; hence, errors, as will be discussed in more detail below, are often referred to in the sense of probabilities. For example, from a normal distribution as illustrated above, 68 percent of the time the errors would lie within one standard deviation (1σ) of the mean value or estimate of the measurand.

In the above example in a 1σ sense, the time error after 1 s is $1 \times 10^{-11} \times 1 \text{ s} = 10 \text{ ps}$ (picosecond = 10^{-12} s). After 100 s, the clock will be $10 \text{ ps} \times \sqrt{100} = 100 \text{ ps}$ away from the origin. The average deviation time of a million such clocks would be $100 \text{ ps} / \sqrt{1,000,000} = 0.1 \text{ ps}$, hence one can see the value of ensembling clocks.

Because of the random-walk phenomena, the standard deviation of a clock's time error will degrade as the square root of the running time, and hence its time error is unbounded — even in the theoretically ideal-clock case.

We may write the time error of a clock in terms of its frequency offset

as follows: $x(t) = \int_0^t y(t') dt'$.

Hence, if the frequency offset is positive, the time-error ramps early. If the frequency offset, y_0 , is constant, we may simply write the time error as follows: $x(t) = y_0 t$. Early and late are sometimes confusing to people. At the moment a clock is early its reading will be larger than a correct clock, and if late, then smaller. Another confusion sometimes arises

because the period between cycles, P , is the reciprocal of frequency, $\nu=1/P$. When we take the derivative of this equation and normalize it, we have $\delta\nu/\nu=-\delta P/P=y(t)$ — note the minus sign in front of the $\delta P/P$. In other words, if the frequency offset is high, the period, P , is low, etc. The SI second is the accumulation “. . . of 9,192,631,770 periods . . .” derived from the defined cesium resonance. So, for example, if a primary frequency standard measures the second of TAI as being too long, then TAI’s frequency is too low.

Definitions:

The definitions for accuracy, error, frequency instability, precision, synchronization, syntonization, and uncertainty are given in the Glossary and Definitions on page 81. These definitions are generally acceptable within the time and frequency community. As much as possible these definitions have been drawn from the work of the International Telecommunications Union (ITU) and the International Standards Organization (ISO). See also IEEE Standards 1139-1988 and 1193-1994 [34, 35].

Commentary on Measures:

Since the true measurand is never known in reality, the accuracy estimates are usually given with a 1σ (68.3%), 2σ (95.5%), or 3σ (99.7%) — depending upon the confidence level desired. The percentages given are for a normal distribution. To have a valid accuracy estimate, both the random as well as the systematic errors have to be included. For frequency accuracy the measurand is the SI second. For time accuracy the measurand is UTC, or one may specify accuracy with respect to a network reference clock, for example.

The definition of precision is somewhat vague. It is often used in time and frequency metrology as defined in the dictionary. Sometimes, more specifically per the definition given above, it is used to describe the uncertainty of a measurement. The traditional standard deviation of the individual measurements taken around the mean value is often quoted as the precision of the measurement. Though this is not an unreasonable descriptor, on the other hand, as will be shown below, it can be very misleading. Hence, the generic use of the word is probably safer, and other measures should be used to be more specific in time and frequency systems specification and characterization.

The standard deviation is not recommended as a measure of frequency instability because the long-term frequency behavior of most clocks tends to walk off, and the standard deviation appears unbounded. Both the IEEE and the ITU have recommended measures that are convergent and well-behaved in spite of the apparent walk-off phenomena exhibited by most clocks. (See below.)

There is sometimes a confusion between instability and stability, inaccuracy and accuracy; though in practice it is seldom a problem. As explained in the text of this application note, the normalized frequency

instability can be written as a dimensionless number; 1×10^{-12} for example. A clock having this instability would be stable to one part in 10^{12} . As discussed in this text, the terms are often used interchangeably because of the lack of confusion.

The IEEE and ITU recommended measures for instability may be described as follows: Consider three sequential time error measurements of a clock, x_n , x_{n+1} , and x_{n+2} , spaced by a measurement interval τ . As discussed in the text, the normalized frequency departure averaged over the n to $n+1$ interval is given by $y_n = (x_{n+1} - x_n)/\tau$; or in terms of finite difference notation this may be written: $y_n = \Delta x_n/\tau$, where the Δ denotes the first finite difference for the n^{th} interval.

Similarly, the average frequency departure for the next interval may be written $y_{n+1} = \Delta x_{n+1}/\tau$. The instability in this clock for its frequency averaged over the first τ interval to the next τ interval may be represented by the change in frequency: $y_{n+1} - y_n = \Delta y_n$. Now the difference of the difference is called the second difference and is denoted Δ^2 .

Hence, from the above equations we may write the following:

$\Delta y_n = \Delta^2 x_n/\tau$. If we compute the sum of the squares of these second differences for $n = 1$ to $N-2$, where N is the number of time error measurements in a series for a particular clock, and then divide by $2(N-2)$, we have what is called an estimate of the two-sample variance, AVAR. We divide by $N-2$ because that is the number of entries in the sum, and we divide by 2 so that AVAR is equal to the classical variance in the case where the y_n s are random and uncorrelated as is the case for classical cesium-beam and rubidium gas-cell frequency standards. The equation for the two-sample variance may be written as follows:

$$\sigma_y^2(\tau) = \frac{1}{2\tau^2} \left\langle \left(\Delta^2 x \right)^2 \right\rangle = \frac{1}{2} \left\langle \left(\Delta y \right)^2 \right\rangle \quad (\text{A1})$$

where the brackets, " $\langle \rangle$," denote an infinite time average. As in the example above, the average of the second difference is simply taken over the data length. The longer the data length, the better is the confidence on the estimate.

There are five different noise types used to model time and frequency devices: white-noise time or phase modulation (PM), flicker or $1/f$ PM, white-noise (random and uncorrelated) frequency modulation (FM), flicker-noise or $1/f$ FM, and random-walk FM. The white-noise FM is classical for atomic clocks and is like our coin toss experiment. As explained above, in this case the time deviations are random-walk in nature. This is because the integral of the frequency is proportional to the time and the integral of white noise is random walk. The classical variance is nonconvergent for the last two noise types. The two-sample variance is not only convergent for all the noise types, but with the observation of the dependence of the variance while the averaging time τ is changing, the type and level of noise can be inferred except for white-noise PM and flicker-noise PM, which have similar τ dependence. The value of τ can be easily changed in the analysis software.

As an illustration of a $\sigma_y(\tau)$ diagram, Figure A1 portrays the region of instabilities for the most important kinds of precision clocks and oscillators that are now in use by the Time and Frequency community.

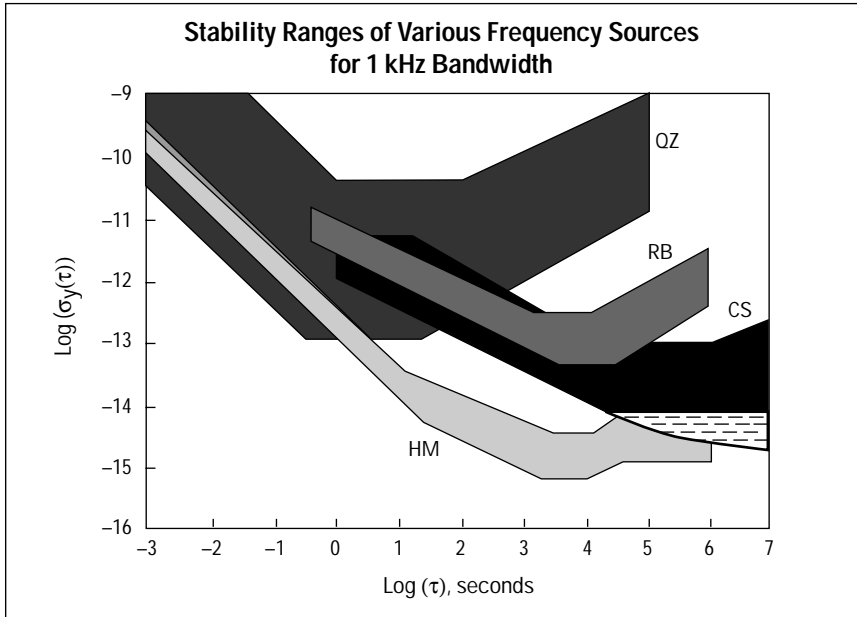

Figure A1. A frequency stability diagram, $\sigma_y(\tau)$, for most of the precision clocks and oscillators used widely within the time and frequency community and by an ever-increasing number of users of precision timing devices. The dashed region at the bottom of the cesium (CS) stability plot shows the improved long-term stability of the HP 5071A Frequency Standard. QZ=Quartz Crystal Oscillator, RB=Rubidium Gas-Cell Frequency Standard, CS=Cesium-beam Frequency Standard, HM=Active Hydrogen-Maser Frequency Standard.

The modified two-sample variance, MVAR, was developed in 1981 to remove the ambiguity mentioned for AVAR in the previous paragraph. MVAR removes this ambiguity by introducing, in the software statistical analysis package, a bandwidth modulation. In equation (A1) on the previous page, there are three time-error readings making up the second difference, $\Delta^2 x_i = x_{i+2} - 2x_{i+1} + x_i$. If these three time-error values are replaced by three time-error averages, each averaged over adjacent windows of duration τ , then the desired result is obtained. The equation for MVAR may be written as follows:

$$\text{Mod.}\sigma_y^2(\tau) = \frac{1}{2\tau^2} \left\langle \left(\Delta^2 \bar{x} \right)^2 \right\rangle, \tag{A2}$$

where the bar over the x denotes an average over an interval τ .

How well the time of a clock can be predicted depends upon the prediction algorithm, the kind(s) of noise in the clock, how well the systematics are understood and have been modeled, and the kind(s) of measurement noise and how well they have been averaged or filtered. The systematic effects are often driven by environmental changes — such as may be caused by temperature effects. Hence, to perform satisfactory prediction it may be necessary in some cases to factor in environmental parameters.

Optimum predictors have been designed in many clock applications. Here optimum means in a minimum squared error sense. It may be shown that if the systematics and the measurement noise have been properly dealt with, then the optimum prediction error for the random part of the clock's behavior is given by $x_{\text{rms}}(\tau_p) = K(\alpha)\tau_p\sigma_y(\tau_p)$. This is the root-mean-square prediction error for a prediction interval τ_p , and the $K(\alpha)$ depends upon the kind of limiting noise in the clock. For the five noise types outlined above ($\alpha = +2, +1, 0, -1, -2$), $K(\alpha)$ has the following values: $2/3, \sim 1, 1, 1.2$, and 1 , respectively. The optimum prediction algorithms are different for each of the five noise types. For the even integer values of α , they are simple and can be deduced from the powerful and useful statistical theorem that the optimum estimate of a white-noise process is the simple mean. For the odd values of α , the prediction algorithms are complex, but simple ones have been designed that are close to optimum. In reality, most clocks are characterized by more than one noise type and the prediction algorithms become correspondingly more complex, but prediction procedures can be designed to be very tractable and close to optimum.

During the late 1980s, the telecommunications community expressed a need for a useful variance measure for characterizing network performance. At the same time, the time and frequency community had a need for a variance measure of measurement noise and of time and frequency transfer and distribution systems. The time variance, TVAR, was developed to satisfy these needs and has been adopted by both communities. TVAR has a direct mathematical relationship to MVAR, and may be written as follows:

$$\begin{aligned}\sigma_x^2(\tau) &= \frac{\tau^2}{3} \text{Mod.}\sigma_y^2(\tau) \\ &= \frac{1}{6} \left\langle \left(\Delta^2 \bar{x} \right)^2 \right\rangle,\end{aligned}\tag{A3}$$

where the 6 in the denominator normalizes TVAR to be equal to the classical variance on the time residuals in the case of classical white-noise PM — in contrast to the above where $\sigma_y^2(\tau)$ has been normalized to be equal to the classical variance on the frequency residuals for classical white-noise FM. White-noise PM is the theoretical limiting noise for measurement systems and for networks, while white-noise FM is the theoretical limiting noise for classical atomic clocks.

The above five values of α have proven very useful in modeling the random fluctuations observed in precise time and frequency systems. This α actually denotes the exponent on the Fourier frequency, f , for the spectral density, $S_y(f)$. The spectral density is a measure of the power present at different Fourier frequencies. The Fourier frequency, in contrast to the carrier frequency, is associated with the power in the residuals (i.e., the fluctuations of the frequency $y(t)$) around the nominal carrier frequency value. Suppose a quartz crystal oscillator has

a carrier frequency of 5 MHz and its frequency is temperature-dependent. If the environmental temperature for this standard goes up and down on a daily basis, we would expect the frequency fluctuations to have a strong Fourier frequency component at one cycle per day. A spectral density plot of $S_y(f)$ would show this bright-line component at $f = 1 \text{ cycle per } 86400 \text{ seconds} = 0.000\ 011574 \text{ Hz}$.

These five values of α are power-law spectral density models, $S_y(f) \sim f^\alpha$. In contrast to the example above power-law spectral densities do not exhibit bright-line components. Rather, these models represent a performance over a band of Fourier frequencies. A classic illustration is the previously mentioned coin-toss experiment, which is also analogous to the ideal atomic clock. In this case, frequency fluctuations are random and uncorrelated with respect to the carrier frequency value. These residuals have what is called a white-noise spectral density in which case all Fourier frequencies are equally probable. For example, a clock with white-noise frequency modulation has the same amount of power density causing the clock's frequency to fluctuate one cycle per day as that causing it to fluctuate one cycle per second, or one cycle per hour, or at any other rate. In this case, α is equal to zero; that is, the spectral density of the Fourier frequency fluctuations is equal to a constant since $f^0 = 1$. The other values of α are also useful in modeling precision clocks and timing systems. For instance, $\alpha = +2$ (white-noise time or phase modulation (PM)) is the limiting noise model for an ideal time transfer system or time or phase difference measurement system. The models with $\alpha = +1, -1,$ and -2 are experimentally useful but don't have a strong theoretical basis at the current time.

Since the time residual fluctuations are the integral of the frequency fluctuations, it can be shown that for these power-law model processes, the spectral density of the time residuals, $S_x(f) \sim f^\beta$, and $\beta = \alpha - 2$. So in the case of white-noise PM just discussed, where $\alpha = +2$, then $\beta = 0$, all Fourier frequencies of the time fluctuations have equal power density. Both the IEEE and the ITU have recommended $S_y(f)$ and $S_x(f)$ as useful measures of clock performance. These are called frequency-domain measures of stability.

The three variances (AVAR, MVAR, and TVAR) are called time-domain measures of stability, and have the additional virtue that the above spectral densities can be written in terms of these variances. In fact, the dependence of these variances has a close correspondence to

the Fourier frequency dependence. Specifically, if AVAR, MVAR, and TVAR are proportional to τ^μ , $\tau^{\mu'}$, and τ^η , respectively, then $\alpha = -\mu - 1$, $\alpha = -\mu' - 1$, $\beta = -\eta - 1$, and $\eta = \mu' + 2$. The corresponding ranges of values over which these variances follow these three equations are $-2 \leq \mu < 2$, $-3 \leq \mu' < 2$, and $-1 \leq \eta < 4$, respectively, and are illustrated in Table A1. Table A2 shows the mathematical representations for the three time-domain variances. Table A3 provides the actual relationships between the frequency-domain measures cited above and the time-domain measures — remembering that $\text{TVAR} = \tau^2 \text{MVAR}/3$. Of course, the square root of each of these three variances are alphabetically denoted ADEV, MDEV, and TDEV, respectively as they were introduced above. They are written symbolically as follows: $\sigma_y(\tau)$, Mod. $\sigma_y(\tau)$, and $\sigma_x(\tau)$, respectively.

From an electrical engineering point of view, all three of these time-domain variances have transfer functions into the frequency-domain that remind one of a bandpass filter. For example, the equation giving AVAR in terms of the spectral density is given by:

$$\sigma_y^2(\tau) = 2 \int_0^{f_h} S_y(f) \frac{\sin^4(\pi f \tau)}{(\pi f \tau)^2} df,$$

where f_h is the high-frequency cutoff for the applicable measurement system. The kernel of this integral looks like a variable bandpass filter centered at Fourier $f = 1/2\tau$ and going to zero at $f = 0$ and at $f = 1/\tau$ on either side of the center frequency. Hence, the center of the effective bandpass filter decreases as τ increases. If τ values are taken such that $\tau = n\tau_0$, where $n = 2^i$ ($i = 0, 1, 2, 3 \dots$) and τ_0 is the initial data spacing, then a $\sigma_y(\tau)$ diagram provides an analysis of stability over a nominally square window in the frequency-domain — ranging from $f = 1/2\tau_{\max}$ to $1/2\tau_0$, where τ_{\max} is the largest τ value available from the data set. The transfer functions for the other two variances are similar. For details see reference [31], pp 97-108, and/or [36].

Table A1. AVAR, MVAR, and TVAR ranges of values

α Noise Type	Range of Applicability
+2 White PM	
+1 Flicker PM	
0 White FM	
-1 Flicker FM	
-2 Random Walk FM	

Table A2. AVAR, MVAR, and TVAR mathematical representations

Abbreviation	Name	Expression
AVAR	Two-Sample or Allan Variance	$\sigma_y^2(\tau) = \frac{1}{2} \langle (\Delta y)^2 \rangle$ $= \frac{1}{2\tau^2} \langle (\Delta^2 x)^2 \rangle$
MVAR	Modified Allan Variance	$\text{Mod. } \sigma_y^2(\tau) = \frac{1}{2\tau^2} \langle (\Delta^2 \bar{x})^2 \rangle$
TVAR	Time Variance	$\sigma_x^2(\tau) = \frac{1}{6} \langle (\Delta^2 \bar{x})^2 \rangle$

Table A3. Relationships between frequency-domain measures and time-domain measures

Noise Type	$S_y(f)$	$S_x(f)$
White PM	$\frac{(2\pi)^2}{3f_h} [\tau^2 \sigma_y^2(\tau)] f^2$	$\frac{1}{\tau_0 f_h} [\tau \sigma_x^2(\tau)] f^0$
Flicker PM	$\frac{(2\pi)^2}{A^*} [\tau^2 \sigma_y^2(\tau)] f^1$	$\frac{3}{3.37} [\tau^0 \sigma_x^2(\tau)] f^{-1}$
White FM	$2 [\tau^1 \sigma_y^2(\tau)] f^0$	$\frac{12}{(2\pi)^2} [\tau^{-1} \sigma_x^2(\tau)] f^{-2}$
Flicker FM	$\frac{1}{2\ell n 2} [\tau^0 \sigma_y^2(\tau)] f^{-1}$	$\frac{20}{(2\pi)^2 9\ell n 2} [\tau^{-2} \sigma_x^2(\tau)] f^{-3}$
Random Walk FM	$\frac{6}{(2\pi)^2} [\tau^{-1} \sigma_y^2(\tau)] f^{-2}$	$\frac{240}{(2\pi)^4 11} [\tau^{-3} \sigma_x^2(\tau)] f^{-4}$

* $A=1.038 + 3\ell n(2\pi f_h \tau)$

In considering an uncertainty specification, the above three time-domain variances have proven very useful in time and frequency metrology for characterizing the random or stochastic processes in clocks, oscillators and sundry time and frequency systems. However, it is very often the case that systematic effects, rather than random effects, limit the ultimate performance of both clocks and oscillators as well as time and frequency transfer and dissemination systems. An uncertainty specification should reflect the one-sigma combination of both the systematic and the random effects. They are usually combined as the square root of the sum of the squares. If the vendor of a product wishes to have a more conservative specification than would be given by a one-sigma number, a two- or three-sigma number may be used, but it is good to so designate. The distribution of errors may not always follow a normal distribution for systematic effects. Even for random

effects, non-normal distributions are observed from time to time. Following the above procedure is in essential conformity with the BIPM's guideline on uncertainty, and this procedure is distribution insensitive.

One of the systematics that often occurs in precision oscillators is frequency drift. Frequency drift occurs in all quartz-crystal oscillators and rubidium gas-cell frequency standards. Some cesium-beam frequency standards exhibit frequency drift — though the amount of drift is usually very small. Hydrogen masers exhibit frequency drift unless the resonant cavity used to bring about the maser oscillation has an active servo control keeping the cavity resonance on the frequency of the hydrogen atom. In addition, the wall coating of the cell inside the resonant cavity containing the hydrogen atoms must remain the same over time, or the hydrogen clock may exhibit frequency drift.

The time error caused by frequency drift is given by $\frac{1}{2} Dt^2$, where D is the amount of the frequency drift and t is the time since the clock was both synchronized and syntonized. D is $y(t)/t$, where $y(0) = 0$ due to being syntonized at that point in time. This time error is sometimes called the time-interval error (TIE). The frequency inaccuracy caused by frequency drift is given by Dt . Frequency drift, of course, is one form of instability and affects the measures outlined above as follows:

$$\sigma_y(\tau) = \text{Mod.}\sigma_y(\tau) = \frac{D\tau}{\sqrt{2}}$$

For the time stability measure the $\text{TIE} \cong 1.2 \sigma_x(\tau)$ due to frequency drift, where τ is now the time since synchronization and syntonization. The time interval error is important in setting up a network in order to know how often the clocks need to be calibrated to avoid exceeding some TIE or to have an adequate “holdover” time.

Since the uncertainty needs to combine the errors from both the systematic as well as the random parts of the timing system, it is apparent that there will be a dependence of the uncertainty on the averaging time since the random part is almost always τ dependent. As an important example, consider the case where two clocks are being compared and the limiting measurement noise is white-noise PM. It has been shown that the uncertainty in the frequency comparison due to this kind of measurement noise decreases as $\tau^{-3/2}$ and is given by $2 \times \text{Mod.}\sigma_y(\tau)$. The frequency estimate, in this case, is deduced from the slope of a linear regression to the time-difference measurements taken as a time series between the two clocks. Because the white-noise PM tends to average away so quickly, it is almost always the case that the systematics dominate in the long-term. Hence, in specifying an uncertainty an averaging time may also need to be given. A lot of effort has been put into uncertainty specification documents, but that which is most helpful is experience and common sense.

Appendix B

Stability Analysis of Harrison-like Chronometers

The genius of John Harrison's work had such far-reaching impact on the world's timekeeping that we elected to document his monumental contribution. We have been fortunate to obtain some of the original data from some early Harrison-like chronometers. The word chronometer was given to a seaworthy clock of which Harrison built only five. His great success inspired others as they patterned their designs after his pioneering work. Specifically, we will include some data from Kendall and Mudge chronometers. The Kendall Clock, K-1, was made famous, as it was of great assistance to Captain James Cook in his exploration of the Pacific Ocean regions.

Before making chronometers, Harrison's clockmaking skills were being developed for tower clocks, grandfather clocks and the like. As mentioned before, his big contribution came from removing the effects of the environment on timekeeping uniformity. He had an insatiable desire for learning, and was apparently largely self taught. He learned his woodworking skills from his father, and the mechanics of motion from a book containing a Cambridge lecture series given by Nicholas Saunderson. This and Newton's Principia were apparently his guide.

John Harrison finished his first pendulum clock when he was 19. The Bocklesby Park tower clock, finished in 1722 when he was 29, is still running and is made mostly of wooden parts. He avoided sticky oils, which changed viscosity with temperature, by using a special hardwood which exuded its own natural oil. He later developed the bi-metallic strip concept to accommodate changing temperatures. The concept of bearings also came out of his creative mind. Some of the land clocks made by John Harrison with the assistance of his brother have been reported to have accuracies of one second a month, which is astounding for that era.

Having a clock with which to compare was a serious problem for them. He and his brother devised a sidereal clock composed of the edge of a window in their home and a neighbor's chimney. As this would provide occultation of a particular star as the earth spun against the celestial sphere, they would mark the time on their local clock. Apparently, they could do this to better than a fraction of a second, but measurement noise undoubtedly was a significant problem. If they achieved accuracies better than a second a month (4×10^{-7}), this is only about forty times worse than the annual spin-rate variations of the earth!

A pendulum clock will not work at sea because its time uniformity is dependent upon the regular motion of a swinging bob. Newton, envisioning this irregular motion of a rolling, rocking ship added on top of

an attempted pendulum chronometer, implied that a seaworthy clock capable of determining accurate longitude may never be built. Harrison devised a counter-rotating pair of barbell-like pendulums connected by springs at the top and bottom, so that one spring was under compression while the other was extended and vice versa — designed so that motion would affect one half in the opposite way to the other half. The net effect was for the chronometer to be independent of the motion of its supporting platform. This clock movement came to be known as the grasshopper escapement and was used in H-1, Harrison’s first seaworthy chronometer. H-1 was tested on a trip to Lisbon and back to London and met the qualifications for the Crown’s £20,000 prize (maintaining accuracy of three seconds per day), but he told the Longitude Board he could do better. His chronometer development continued in its sophistication from there.

John Harrison had to build three more chronometers to partially satisfy the critical Longitude Board. H-4 made the voyage to Jamaica — losing only five seconds in 81 days at sea. It returned to London two days after Harrison’s 69th birthday with a combined total error of two minutes over five months. Though he was very discouraged by the inordinate delays in getting the prize money, his work inspired many other clockmakers.

We were successful in obtaining two sets of time-error data from these historical jewels made more than two centuries ago [37, 38, 39]. The Kendall No. 1 chronometer data was actually taken starting in July 1984 — with daily readings almost every day for 1,082 days. Undoubtedly, this chronometer was operating far worse than at its prime — being well over 200 years old. Two hundred and three days of data were analyzed on the Mudge No. 1 chronometer, and the data were taken in 1777, probably part of its evaluation. Both of these easily met the prize-money requirements though the environment was rather benign compared to conditions at sea.

For the analysis of the data we have used two approaches: first, we have employed the instability analysis procedures outlined in Appendix A, and as written into a software package developed for characterizing GPS atomic clocks [40]. Since the long-term performance of these clocks is a key issue, we have incorporated a recent development coming from NIST [41] which gives improved confidence on the long-term stability estimates; it is called total sigma — using the same statistical measure as outlined in Appendix A, but with better confidence on the values. The difficulty with the first approach is that we need a reasonably long data set of clock time errors in order to perform the analysis. We obtained all we could within reason. From the data available, we were able to calculate the time prediction error per Appendix A for inclusion in Figure 12.

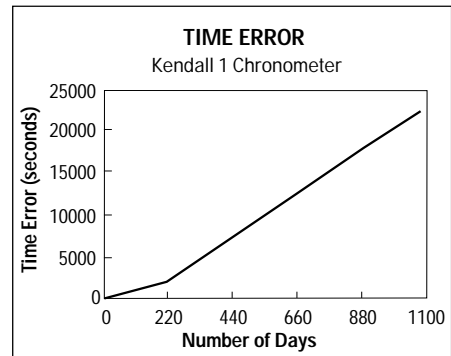

Figure B1. The time error of the famous K-1 (Kendall No. 1 Chronometer). The overall chronometer rate is 20.84 seconds per day.

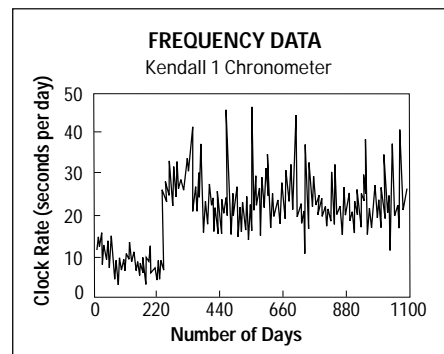

Figure B2. A plot of K-1’s clock rate (frequency). The step in frequency is obviously concurrent with its transfer to a new gallery. During the data acquisition it was not always humanly possible to be there in time to wind it before it stopped. After stoppage (10 in the first gallery and 42 in the second), it was rewound and reset. While in the second gallery, there was some indication that it tended to run slightly fast for a while following a stoppage.

The second approach avoids the need for a data set taken as a time series. For these Harrison-like clocks, such time-error series are rarely available. But if we have a time-prediction error over a given length of time, Figure 12 is directly amenable to plotting that point as obtained from experimentation. From that data point, we can effectively work the problem backwards and infer that the stability must be better than some number in order to obtain that prediction error. The time-error prediction equations given in Appendix A are under the assumption of optimum prediction. In other words, the root-mean-square prediction error cannot be better than the number given by these equations — they provide a lower limit. These equations are also dependent upon different types of noise, and so the assumed model needs to be close to reality for validity of the calculations. We will see that these assumptions are reasonably met. The analysis procedure will follow a similar pattern as discussed in the illustrative example given in the text.

Figure B1 is the time error plot for the famous Kendall K-1 Chronometer with a beginning date of 16 July 1984. Readings were taken once a day as often as possible and at about the same time each day. After 230 days the chronometer was moved to a different gallery. The total experiment length was 1,082 days. On days when readings could not be taken, reasonable interpolations were inserted. From the knee in the curve, it is obvious the chronometer changed frequency after being moved to the second gallery. This could be due to temperature and/or humidity and/or a change in the position of the chronometer with respect to the earth's gravitational vector.

Figure B2 is a clock rate or frequency plot of the same data. It is apparent that the frequency stability deteriorated while it was in the second gallery. There are also several large frequency steps, most of which go positive from the nominal average value during this latter segment of data. The clock suffered far fewer stoppages while in the first gallery. In the second gallery, the frequency tended to go high for a few days after the clock was rewound following a stoppage.

Figure B3 is a histogram plot of the data in Figure B2. The data values are in units of seconds per day. The double distribution is a result of the different clock rates at which K-1 nominally operated in the two different galleries housing the clock during data acquisition. Notice that the upper distribution is skewed to the higher clock rate values. These higher skewed values appeared to occur following some of the occasional weekend stoppages.

Since K-1 is over 200 years old, we felt it necessary to give it every advantage because of the natural deterioration of all mechanical devices; hence, we only analyzed in detail the first segment of the data. Figure B4 is a plot of the time error for this segment after removing the mean frequency. This would nominally be equivalent to a calibrated clock rate correction. Notice that by this procedure the peak error reduces from about 2,000 seconds down to 150 seconds. One sees a

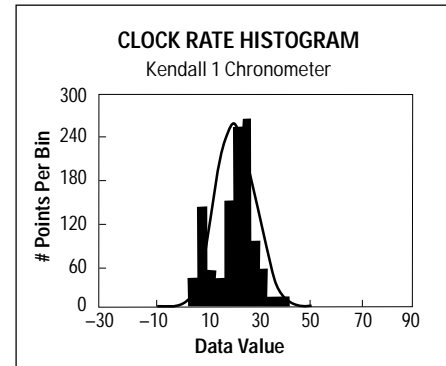

Figure B3. A Histogram of the K-1 clock rate data with each point being a one-day average. The distribution clearly does not follow the normal distribution curve also indicated. The double distribution is a result of the different clock rates at which K-1 nominally operated in the two different galleries housing the clock during data acquisition. Notice that the upper distribution is skewed to the higher clock rate values apparently as a result of occasional stoppages.

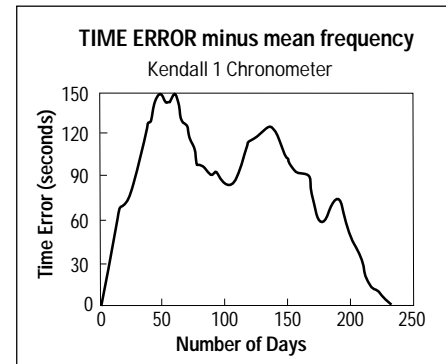

Figure B4. A time error plot after subtracting a calibrated frequency offset from the numbers over the first 230 days — the time it was housed in the first gallery. As compared to Figure B1, notice that this calibration reduces the peak-to-peak error by about a factor of 150. Notice also the general parabolic shape to the curve — indicative of a negative frequency drift.

nominal parabolic shape to this curve that could be caused by a frequency drift. A linear regression line was subtracted from the frequency data for this first segment, and Figure B5 shows the remaining time errors. In this case the peak error drops by more than a factor of two.

Following the guidelines given in Appendix A and using the total variance approach developed by NIST, we show the frequency stability of both the first and second segments of the data in Figure B6. Notice that the first segment is significantly lower — quantifying that which is visually apparent in Figure B2. A nominally flat frequency stability curve like this one — proportional to τ^0 — is observed in a large variety of clocks and is characterized by what is called flicker noise, FM where $S_y(f)$ is proportional to $1/f$. In a frequency stability plot, this is often called the flicker floor. We see that K-1, after more than 200 years of operation, has a flicker floor of about 1.5×10^{-5} or about 1.3 seconds per day. From Appendix A we know that the time error of prediction or the timekeeping ability of such a clock is given by $1.2 \tau_p \sigma_y(\tau_p)$; hence, for one day it is 1.6 seconds. This nicely meets (~90% confidence interval) the requirements of 3 s/day set for the Crown award money even after the instrument is over 200 years old. Of course, the environment for the experiment was very benign, and we have accounted for both the clock rate offset and its frequency drift.

A flicker-noise model is the reason for the upward sloping behavior of the Harrison-like chronometers in Figure 12. Notice in Figure B6 that for large averaging times the second segment appears to average down toward the extrapolated values for the first segment. This would indicate that the chronometer is still successfully hunting for its designed resonance frequency in spite of the degraded operating conditions of the second gallery.

Figure B7 is a plot of the time error of the Mudge Chronometer data taken in 1777. This is a continuous time-error series taken over 203 days — one measurement per day. The clock-rate offset is quite a bit smaller for the Mudge chronometer than for the Kendall. Since this can be calibrated out, this should not be used as the most significant criteria of clock performance. Figure B8 is the corresponding frequency plot, and one can see evidence of a change in the average frequency starting at about day 165. If a calibrated mean frequency is subtracted from the data, the resulting timer error is shown in Figure B9. The change in slope at day 165 clearly shows a frequency step change at that point.

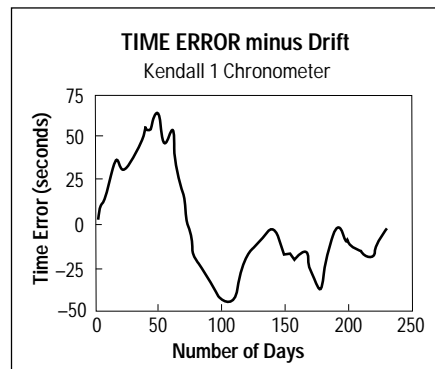

Figure B5. After subtracting a frequency drift as estimated from K-1's frequency data by simple linear regression, the residual time errors were calculated and are plotted here. In this case, as compared to Figure B4, the time errors are only reduced by a little over a factor of two. How much the timing errors will be reduced by frequency drift calibration is a function of the size of the drift as compared to the random clock noise. Calibrating frequency drift in quartz-crystal oscillators and rubidium gas-cell frequency standards is often very beneficial. It is not surprising that there is some frequency drift in a mechanical timing device.

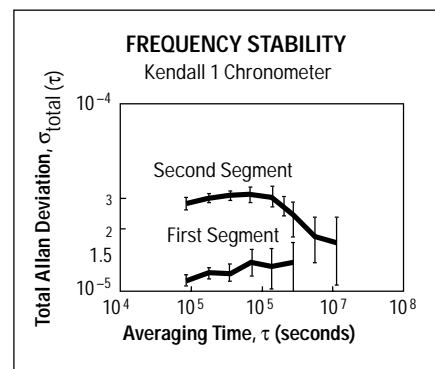

Figure B6. A plot of the frequency stability for the data taken in each of the two galleries. K-1 was about a factor of two less stable during its time in the second gallery than in the first. Notice the hump in the stability plot for τ values of the order of one to two weeks. This is apparently due to the steps in frequency occurring every few weeks. Notice also that the long-term $\tau = 128$ days value is almost in line with extrapolated stability curve from the first segment. In other words, it appears that whatever caused K-1's rate to go high for a few days, this effect tended to average out over long enough time — a very good attribute.

One wonders if something was done to the clock to induce this change. This is clearly not approximated by a parabola, so no frequency drift was subtracted. The frequency stability of this clock is shown in Figure B10 — a most commendable result for that period. The lower curve is $\text{Mod.}\sigma_y(\tau)$, as explained in Appendix A, and the upper curve is $\sigma_y(\tau)$. $\text{Mod.}\sigma_y(\tau)$ was employed to detect any measurement noise. The steep, downward slope at the shortest τ values is indicative of some. The level is given by

$$\frac{\tau \text{Mod.}\sigma_y(\tau)}{\sqrt{3}} = 0.14 \text{ seconds at } \tau=1 \text{ day, which is also a most com-}$$

mendable result for that period.

This is the reason for the flat bottom portion — indicative of measurement noise — for the data shown in Figure 12 for the Harrison-like chronometers. The Mudge data appears to hit a flicker floor at about 1.7 or 1.8×10^{-6} for the large τ values — of the order of weeks. This is about a factor of ten better than would have been necessary for the Longitude prize.

The frequency change shown by the slope change in Figure B8 was measured, and the first and second sets (before and after the frequency step change) were tested for the noise type of the residuals. Figure B11 is a plot of the frequency stability for the first 164 days. In an ideal frequency standard, the residuals would be random and uncorrelated — like our coin-toss experiment in Appendix A. In this case, the frequency stability diagram, $\sigma_y(\tau)$, would behave as $\tau^{-1/2}$. This is also called white noise frequency modulation (FM), and a white noise FM line has been drawn on Figure B11 for illustrative and comparison purposes.

For longer τ values the stability values rise up above a $\tau^{-1/2}$ slope indicating that the noise is moving toward a flicker-noise like process. That it follows as close as it does to the theoretically ideal $\tau^{-1/2}$ behavior is astounding for a clock of that vintage.

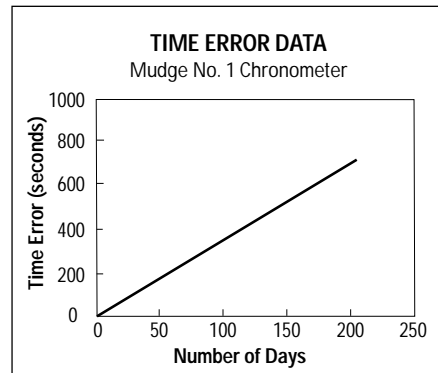

Figure B7. A plot of the Mudge No. 1 chronometer data taken in 1777 A.D. over a 203 day interval — the chronometer’s rate being determined over a one day interval. The time error shown has an overall rate of 3.623 seconds per day with very little noise around this slope. If observed carefully, a slight change in slope occurs toward the end of the data — at day number 165.

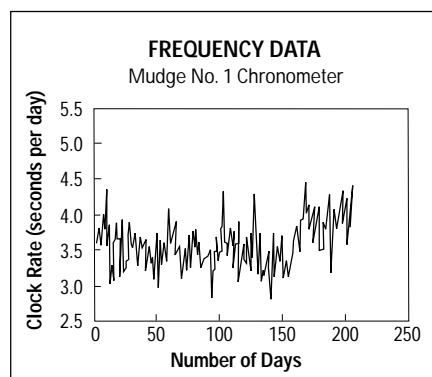

Figure B8. A plot of M-1’s daily-average frequency values. The noise in the chronometer and the frequency step at day number 165 are more apparent.

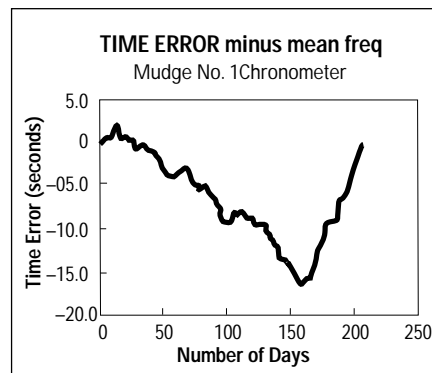

Figure B9. After subtracting a calibrated clock rate of 3.723 s/d from the data, the timer error is plotted. By this approach the frequency step is readily apparent. Any frequency drift appears to be below the noise.

Another simple test for non-whiteness of the noise has been developed in which the ratio of the classical variance (standard deviation squared) to the two-sample or Allan variance is calculated. It is both a necessary and a sufficient test for non-whiteness if this ratio is not 1. Furthermore, its departure from 1 is indicative of the kind of noise and the degree of time dispersion that characterizes the clock [42]. For this data set the ratio was 1.26. If the noise is white FM, then the uncertainty on the optimum estimate of the frequency, which is the simple mean, is given by the standard deviation of the mean as explained in Appendix A. Because the noise is close to, but not white, we used the above ratio as the dispersion factor for the uncertainty of the frequency estimates before and after the step. The statistical behavior of the second set was very similar to the first. The clock rate (frequency) step size was (0.50 ± 0.06) seconds/day.

For the electrical engineer or physicist who may be reading this, and for any others interested in the spectral density of these clock residual fluctuations, a fast Fourier Transform was made of both clock sets. Nothing untoward was observed. Perhaps one small point of interest was that the last 512 days of the Kendall No. 1 Chronometer data set showed a slight indication of a one-cycle-per-week Fourier component being present (see Figure B12). The amplitude of this 1/7 cycle-per-day component is about ≈ 1.4 seconds per day. Not surprisingly, all the data sets viewed in total or in segments had a negative slope to the spectral density plot — indicating a non-whiteness in their residual behavior. The line fit to the Figure B12 data is $f^{-0.83}$ — very close to flicker noise, which is f^{-1} .

One of the principle values of clock ensembles is to sense and reject abnormal behavior in a clock, such as the above frequency step. In this way and because of the random uncorrelated nature of the noise, the ensemble time can be better than the best physical clock making up the ensemble. Even so, the reliability, ruggedness and performance of these Harrison and subsequent chronometers are truly astounding and have clearly revolutionized how we navigate. GPS is having a similar impact now.

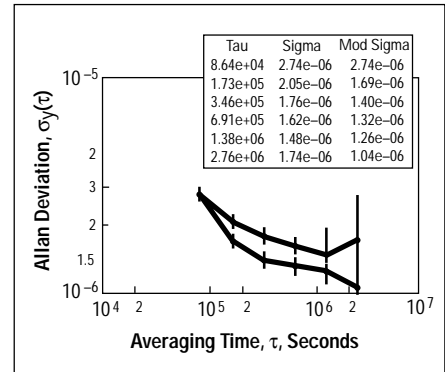

Figure B10. Frequency Stability of Mudge No. 1 Chronometer.

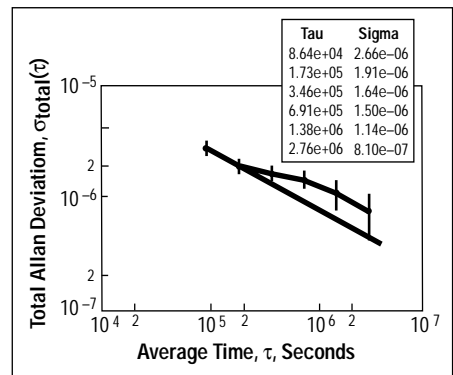

Figure B11. Frequency Stability of Mudge No. 1 Chronometer for first 164 days.

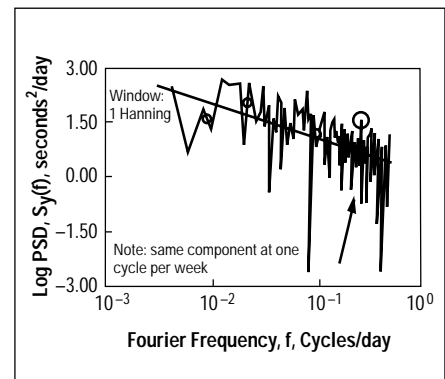

Figure B12. Power Spectrum of Kendall No. 1 Chronometer for last 512 days.

Appendix C

Time and Frequency Transfer, Distribution and Dissemination Systems

Tables C1 and C2 are taken from the International Telecommunication Union's handbook entitled, *The Selection and Use of Precise Frequency and Time Systems*. These tables provide an overall summary of the current methods that are available for both obtaining a time and frequency calibration source and for comparing clocks located remote to each other. In addition, where UTC is available, the time accuracy with which it can be obtained is also given.

Figures 13 and 14 show the frequency and time stability of some of these techniques for time and frequency distribution, dissemination or transfer. Caution should be exercised in using any of these values because there is often a path dependence as well as a time dependence; in other words, the locations of the clocks can make a difference along with the time of day or night, the time of year, and perhaps where we are in the solar sunspot activity cycle.

For the best calibration or comparison of a clock, a systems approach is often the best, considering the following questions: What are the characteristics and labor intensity to use the different techniques for calibration or comparison? What are the overall associated measurement uncertainties — considering both the random and systematic effects? What are the nominal characteristics of the clock being calibrated or compared and how do the measurement uncertainties impact the calibration or comparison process? There are some extremely cost-effective ways now available to transfer, distribute or disseminate high-accuracy time and frequency signals. Good planning should also include considerations for reliability and robustness.

Meanings of designations in Table C1:

- 1 HF (High Frequency) broadcast (3.0 MHz – 30 MHz).
- 2 Rec. (Recommendation) 768 of the Study Group VII of the ITU-R.
- 3 LF (Low Frequency) broadcast (30 kHz – 300 kHz).
- 4 Loran-C, 100 kHz ground-based navigation chain of transmitters.
- 5 VLF (Very Low Frequency) broadcast (3 kHz – 30 kHz).
- 6 Omega, each station operates a different VLF carrier frequency — coordinated globally.
- 7 GOES (Geostationary Operational Environmental Satellite) East and West satellite covers the Americas.
- 8 INSAT (Indian Satellite)
- 9 DBS (Direct Broadcast Satellite)

Table C1. Characteristics of some potential sources and dissemination techniques for precise time-and-frequency reference information

Type	Typical time-transfer accuracy capability	Typical frequency transfer capability	Coverage	Availability	Ease of Use	Approximate relative user cost (\$ US 1995)	Example system	Comments (1995)
HF broadcast ¹	1-10 ms	10 ⁻⁶ to 10 ⁻⁸ (over 1 day)	Global	Continuous, but operator and location dependent	Depends on accuracy requirements	50 to 5,000	Many services worldwide. See Rec. 768 ²	Accuracy depends on path length, time of day, receiver calibrations, etc.
LF broadcast ³	1 ms	10 ⁻¹⁰ to 10 ⁻¹¹	Regional	Continuous	Automatic	3,000 to 5,000	See Rec. 768	Depends on distance from the source and diurnal propagation (ionosphere height)
LF navigation (pulsed)	1 μs	10 ⁻¹²	Regional	Continuous	Automatic	5,000 to 12,000	Loran C ⁴	Northern hemisphere coverage. Stability and accuracy based on ground wave reception.
VLF broadcast ⁵	10 ms	10 ⁻¹¹ (over 1 day)	Global	Continuous	Automatic	4,000	Omega ⁶	Carrier resolution can provide better time accuracy
Television broadcast (terrestrial links)	10 ns for common view	10 ⁻¹² to 10 ⁻¹³ (over 1 day)	Local	Dependent upon local broadcast schedule	Automatic	5,000		Calibration required for timing
Navigation Satellite, broadcast	20-500 ns (See notes in Table C2)	10 ⁻⁹ to 10 ⁻¹³	Global	Continuous	Automatic	3,000 to 15,000	GPS and GLONASS	One day averaging necessary to meet specified frequency transfer capability. Best broadcast system available today with commercial receivers.
Navigation satellite, common view	5-20 ns	10 ⁻¹³ to 10 ⁻¹⁵ (over 1 day)	Inter-continental	Continuous (calculated after the fact)	Automatic data acquisition. Requires post processing.	10,000 to 20,000 per site	GPS and GLONASS	Most accurate, widely used time synchronization method that is available today (1995) with commercial receivers for baselines less than 8000 km.
Meteorological satellite, broadcast	100 μs	Not recommended for frequency transfer	Regional (satellite footprint)	Continuous	Automatic	4,000 to 5,000	GOES ⁷	May not be available during satellite eclipse.
Geostationary satellite multipurpose broadcast	20 μs	5 × 10 ⁻¹⁰	Regional (satellite footprint)	Continuous	Automatic	4,000	INSAT ⁸	Accuracy limited by satellite footprint. May not be available during satellite eclipse.

Table C1. Characteristics of some potential sources and dissemination techniques for precise time-and-frequency reference information (continued)

Type	Typical time-transfer accuracy capability	Typical frequency transfer capability	Coverage	Availability	Ease of Use	Approximate relative user cost (\$ US 1995)	Example system	Comments (1995)
Television broadcast satellite	0.5-10 μ s	10^{-10} to 10^{-11}	Regional (satellite footprint)	Dependent on broadcast schedule	Automatic data acquisition	7,000	DBS ⁹ Satellites	Without correction for satellite position
	10-100 ns	10^{-12} to 10^{-13}	Regional (satellite footprint)	Dependent on broadcast schedule	Post-processing of data required	7,000	DBS Satellites	With correction for satellite movement
Communication satellite, two-way	1-10 ns	10^{-14} to 10^{-15}	Regional (satellite footprint)	Continuous (as scheduled)	Data acquisition can be automatic (depending on satellite). Post processing required.	50,000 per site	North American and European networks exist.	Most accurate operational method at this time.
Telephone time code	1-10 ms	10^{-8} (over 1 day)	Telephone calling range	Continuous	Automatic	100	Europe and North America	Phone line must have same path in both directions. Assumes computer and software availability.
Optical fiber	10-50 ps	10^{-16} to 10^{-17}	Local, less than 50 km	Continuous	Automatic	Transmitter and receiver \$30,000 per set plus cable and underground installation costs.	Dedicated to frequency transfer	Cable must be temperature stabilized, (e.g. 1.5, underground).
	100 ns	10^{-13} to 10^{-14} (over 1 day)	Long distance, 2000 km	Continuous	Automatic	Not applicable. The equipment is a part of a specific communication system.	Synchronous Digital Hierarchy (SDH) network	Part of digital communication system
Microwave link	1-10 ns	10^{-14} to 10^{-15}	Local	Continuous	Automatic	50,000 to 75,000		Sensitive to atmospheric conditions and multipath effects. Must be 2-way to achieve stated accuracy and stability.
Coaxial cable	1-10 ns	10^{-14} to 10^{-15}	Local	Continuous	Automatic	5 to 30 per meter		Sensitive to temperature, VSWR, humidity, barometric pressure.

Table C2. Additional information relating to the practical use of the various alternative sources of time-and-frequency signals

System/Technique	Background Information	Comments on equipment and use
HF broadcasts	<p>There are approximately 13 stations worldwide broadcasting on one or more of the allocated HF frequencies. Several others operate on other HF frequencies. Typical services include standard frequencies, time signals and time intervals, time codes, voice time announcements, and UT1 time information. These services provide a convenient, easy-to-use source of UTC at modest accuracy levels. Although HF signals can be received at large distances, propagation effects can limit received accuracy and stability. Multiple stations operating on the same allocated frequencies may cause mutual interference in some areas. Reception conditions are often highly variable, depending on factors such as season, time of day, solar activity, atmospheric conditions, etc. Some HF services are being shut down in favor of other alternatives. ITU Recommendation ITU-R TF.768 contains a complete listing of HF services, including details of the content and format of the broadcasts.</p>	<p>Inexpensive receivers and antennas available. Diversity receivers use multiple HF frequencies to partially compensate for propagation effects. Simple short- or long-wire antennas are often usable. Other antenna design information can be found in amateur-radio handbooks.</p> <p>Reception is generally better for the lower frequencies (<10 MHz) during nighttime hours and for the higher frequencies (>10 MHz) during daytime hours. Reception may be intermittent due to propagation disturbances and/or interference. Optimum reception is usually during daytime or nighttime hours when the ionosphere is most stable.</p> <p>Voice time announcements provide a few tenths of a second accuracy. For better accuracies down to about 1 ms special measurement techniques and equipment, such as oscilloscopes and electronic counters, may be required. Receiver delay calibration is also necessary for highest accuracy.</p> <p>Frequency-measurement accuracy is limited to about 1×10^{-7} by ionospheric motion. Beat-frequency techniques are often used along with oscilloscopes and/or counters. Frequency measurements may also be inferred from daily time-difference measurements.</p> <p>Calculation of signal path delays is complicated by uncertainties in the number of signal "hops" between the station and the user and the height of the reflecting layer at any point in time. Single hops can usually be assumed for distances of less than 1600 km.</p>
LF broadcasts	<p>This category includes broadcasts operating in the LF band (30 - 300 kHz) that are useful sources of UTC time or frequency but excluding navigation-system broadcasts such as Loran-C. These broadcasts are of two types: (1) dedicated time-and-frequency dissemination services such as DCF77, HBG, WWVB, and JJF2; and (2) stations operating in the sound-broadcasting service that have stabilized carriers and/or additional phase-or-amplitude modulations that provide coded time information. The dedicated services generally use frequencies in the 40 - 80 kHz range.</p> <p>Many of these LF broadcasts provide users with very complete time-of-year information coded form and have found wide acceptance in many timekeeping applications. Time accuracies of less than 1 ms are possible. When used as a frequency standard, LF broadcasts, including the stabilized sound broadcasts, offer calibration accuracies of less than 1×10^{-11} when averaged for about 1 day. Reliable coverage areas of the various broadcasts range from a few hundred kilometers up to 3000 km.</p> <p>For more details on the available broadcasts for time-and-frequency use, see ITU Recommendation ITU-R TF.768.</p>	<p>Relatively inexpensive receivers and antennas are available from commercial sources in regions served by suitable broadcasts. Commercial receivers are self-contained and provide a variety of outputs that can often be specified by the user. More sophisticated phase-tracking receivers are also available which allow users to establish direct frequency traceability to accepted sources for UTC.</p> <p>Typical antenna types for these broadcasts include long-wire designs (e.g., 50 - 100 meters), whip antennas (e.g., 3 meters), air-loop antennas which are helpful in discriminating against interference, and small ferrite-loop antennas.</p> <p>Reception conditions vary with the transmitter power, the user's location, and, in some cases, the season and time of day. For longer paths between transmitter and user, avoid making measurements when there is sunrise or sunset anywhere along the path.</p> <p>Frequency calibrations of local oscillators may be performed by continuously monitoring the phase difference between the local oscillator and the received LF broadcast. Proper evaluation of the resulting phase recordings, however, requires some operator skill and experience in interpreting and accounting for various phase shifts and possible "cycle slips".</p> <p>Destructive interference may occur between the first-hop skywave and the groundwave, causing a sharp drop in received field intensity at certain distances from the transmitter. For a 60 kHz LF broadcast, this distance is about 1200 km.</p>

Table C2. Additional information relating to the practical use of the various alternative sources of time-and-frequency signals (continued)

System/Technique	Background Information	Comments on equipment and use
LF navigation broadcasts (pulsed)	<p>Approximately 65 Loran-C stations scattered throughout the northern hemisphere continuously broadcast high-power navigation signals on a frequency of 100 kHz. These stations are arranged in chains of 4-5 stations each. Each chain transmits groups of precisely controlled pulses at an assigned unique Group Repetition Interval. Because the navigation signals are synchronized and syntonized by atomic standards and are carefully monitored and controlled, they can be very useful as time-and-frequency references.</p> <p>The Loran-C transmissions do not contain complete time-of-day information and are not a direct source of UTC time. However, if a user's clock is initially set to UTC by some other means, Loran-C can be used to keep the local clocks to within a few microseconds of UTC over long periods of time. Frequency calibrations using Loran-C can provide 1×10^{-12} accuracy when averaged over 1 day or more.</p> <p>Although reception from at least three different stations is necessary for navigation, time-and-frequency measurements require reception from only a single station.</p>	<p>Special Loran-C timing receivers and antennas are available commercially. The more expensive models acquire and track appropriate Loran-C signals automatically. Non-automatic receivers require significant operator experience and skill for optimum timing performance.</p> <p>In order to use Loran-C to keep a local clock steered to UTC an output 1 Hz pulse from the receiver can be synchronized to UTC by using "Time of Coincidence" tables published by the US Naval Observatory. These tables give the specific times when the start of the Loran-C signal being received is coincident with a UTC second. Some Loran-C timing receivers can perform this synchronization automatically.</p> <p>At large distances from the station the Loran-C skywave signal may sometimes be used for timing at the 50 - 100 ms level even when the primary groundwave signal is unusable.</p> <p>Seasonal effects on Loran-C propagation may cause timing variations of several microseconds. At this level receiver delays also need to be considered.</p> <p>Frequency calibrations of a local oscillator can be accomplished by recording the phase difference between Loran-C and the local system or by daily measurements of the phase difference using a counter. Accuracies as good as 1×10^{-12} are possible with 24-hour averaging.</p> <p>The development of very low cost Loran-C receivers (under \$1,000) for navigation creates some possibilities for their adaptation for time-and-frequency applications, providing that the necessary technical expertise is available.</p>
VLF broadcast	<p>There are a number of broadcast stations operating in the 10 - 30 kHz range that are useful for time-and-frequency applications. These include broadcasts primarily intended for long-distance communications or navigation but which are highly stabilized in frequency and time by referencing to multiple atomic standards. Propagation is relatively stable over very large distances (thousands of kilometers), which can permit phase-tracking receivers to maintain phase to within a few microseconds over long periods of time. VLF broadcasts typically do not contain complete UTC time information and are useful primarily as a frequency reference.</p> <p>The Omega Navigation System is one VLF system that is useful for time-and-frequency applications. It features eight worldwide, 10-kW transmitters providing continuous and redundant global coverage. Each station transmits the four navigation frequencies of 10.2, 11.05, 11.33, and 13.6 kHz sequentially in a time-shared mode. Other "unique" frequencies in the 10 -13 kHz range are also transmitted by each station.</p> <p>Several nations also operate VLF communication stations that are useful, particularly for frequency calibration. At least some of these stations operate in an MSK (minimum shift keying) mode, requiring the use of special receiving equipment and techniques to recover a phase-stable carrier frequency.</p>	<p>Typical equipment used includes phase-tracking receivers, loop antennas, and chart recorders. Receiving system delays need to be calibrated for best results.</p> <p>Receivers used with MSK transmissions need to reconstruct a phase-coherent carrier by suitable multiplication and mixing. For further information on MSK signals see Note #10 to Table 2 in ITU Recommendation ITU-R TF.768.</p> <p>Omega stations are located in the United States (North Dakota and Hawaii), Japan, Argentina, La Reunion, Liberia, Norway, and Australia. Since each station transmits multiple frequencies in sequence, use of one of the Omega navigation frequencies for calibration requires that a commutator be used to turn the phase-tracking receiver on and off at the proper times in order to receive only the particular frequency of interest.</p> <p>Propagation effects often limit the useful accuracy of VLF signals, especially for very long path lengths. There are, for example, predominant diurnal and annual variations caused by ionospheric changes. Results may also be influenced by unpredictable sudden ionospheric disturbances (SID), which typically alter the ionosphere for 20 - 30 minutes, and by polar cap absorption (PCA) events, which alter the polar ionosphere for up to a week.</p> <p>In addition to the diurnal and annual variations in propagation delays at VLF, other variations have been observed with periods of 27, 29.53, and 14.765 days due to various solar and lunar effects.</p> <p>In recent years the use of VLF broadcasts for time-and-frequency comparisons has declined due to the emergence of other systems and techniques.</p>

Table C2. Additional information relating to the practical use of the various alternative sources of time-and-frequency signals (continued)

System/Technique	Background Information	Comments on equipment and use
Television broadcast (terrestrial links)	<p>A number of different techniques have been tried for time-and-frequency dissemination and comparison that use television broadcast signals. These include the insertion of time-and-frequency information into the television signal, the stabilization of television carrier frequencies and synchronization pulses, and the common-view reception of a single television broadcast at multiple sites within a local area. The first two techniques are still in use in limited geographical areas, but the common-view reception technique is the most widely used television method.</p> <p>The common-view method allows the precise time comparison among multiple sites within the coverage area of a single TV station. Each site simultaneously measures the time difference between a particular synchronization pulse in the TV signal and its local clock. Subtracting the measurements from two different sites provides the difference between the local clocks plus a fixed differential propagation delay. The local clock comparisons have a typical uncertainty of about 10 ns.</p>	<p>Typical equipment needed includes suitable television receivers, antennas, counters, and data recorders. The television receivers must be modified to extract the particular synchronization pulse from the received TV signal.</p> <p>At each measurement site arrange for the local clock pulse to start the counter and the received TV signal to stop the counter. About 10 such once-per-second measurements are usually sufficient to achieve excellent results.</p> <p>Since the measurements must be made simultaneously at each site and the resulting data must be exchanged, active cooperation among the sites is necessary.</p> <p>By making such comparisons each day over a period of time, very accurate frequency comparisons are possible based on the observed changes in the daily time differences. This assumes that the differential propagation path delay remains stable or is independently calibrated each time.</p> <p>The technique is especially advantageous within a limited local region because of its simplicity, relatively low cost, and high accuracy.</p>
Navigation satellite broadcast (continued)	<p>There are two major satellite navigation systems in use as of 1995 which offer outstanding time-and-frequency dissemination capabilities. These are the US Global Positioning System (GPS) and the Russian Global Navigation Satellite System (GLONASS). The US Transit system offers a third choice, but it will not be discussed further in view of its lower accuracy, higher cost, and anticipated limited lifetime.</p> <p>While there are some differences between the two systems in terms of signal structure and content, use of the frequency spectrum, and satellite orbits and configuration, their similarities are much more important for time-and-frequency users. Both GPS and GLONASS employ redundant on-board atomic clocks, continuous global coverage from 21 - 24 operational satellites, precisely timed broadcasts which can be related to UTC(USNO) and UTC(SU), respectively, to within 100 ns, and satellite-position information included in the broadcasts which can be used for accurate path delay compensation by the user's receiver. At least four satellites are always in view from any location (required for navigation), but reception from only one satellite is sufficient for time-and-frequency comparison. For accurate time the receiver's antenna position must also be known.</p> <p>Both GPS and GLONASS are essentially fully operational as of 1995 and provide a combined total of more than 40 satellites for time-and-frequency applications. Commercial development of receivers is proceeding rapidly with a resulting sharp decrease in user costs.</p>	<p>A variety of receivers are commercially available, especially for the GPS broadcasts. Some versions have been produced which can receive both GPS and GLONASS. Very small omnidirectional antennas are usually provided with the receivers. Costs have decreased sharply with the increasing demand and timing receiver packages are available in early 1995 for \$3,000 - \$15,000.</p> <p>Most receivers are highly automated. During initial setup they can be programmed to automatically track enough satellites to determine the receiver coordinates with sufficient accuracy to support submicrosecond timing. Some care must be used in locating the antenna to minimize multipath effects. After setup, receivers can continue to acquire and track all selected satellites in a totally automatic mode.</p> <p>Many receivers can be easily controlled by the user to track only certain satellites at certain times. Time differences between the received GPS signal and a local clock can often be stored in the receiver's memory for later analysis.</p> <p>Although the times of individual GPS and GLONASS clocks differ from the overall satellite system time which, in turn, differs from UTC, sufficient additional data are included in the satellite broadcast formats to allow a receiver to, in principle, adjust its output timing signal to be with about 100 ns of UTC(USNO) or UTC(SU). The actual display and output times, and their relationship to the relevant UTC time scales, may vary from receiver to receiver, depending on the particular manufacturer and model and the effects of Selective Availability in the case of the GPS signals.</p>

Table C2. Additional information relating to the practical use of the various alternative sources of time-and-frequency signals (continued)

System/Technique	Background Information	Comments on equipment and use
<p>Navigation satellite broadcast (continued)</p>	<p>The presence of Selective Availability (SA) on the GPS signal overtly degrades the GPS timing information. A Memorandum of Agreement between the US Department of Defense and the Department of Transportation guarantees the availability of GPS, and the SA level is expected to remain at about the current (1995) level. The civilian use of GPS has surpassed the military use and ratio of civilian-to-military use is expect to continue increasing. It is the intention of the U.S. to discontinue the use of GPS Selective Availability within a decade. Beginning in 2000, the U.S. President will make an annual determination on continued use of GPS SA.</p>	<p>Typical timing accuracies of 20 - 500 ns and frequency accuracies of 10^{-9} to 10^{-13} (depending on various factors) make these navigation satellite systems the best current broadcast source of highly accurate time-and-frequency for use with commercial receivers.</p> <p>Given the level and characteristics of GPS SA, a system approach for obtaining UTC timing information has proven beneficial in inexpensive multichannel receiver designs. Using a systems approach, the final time-and-frequency accuracy and stability will depend on the receiver, the characteristics of the reference clock and the processing algorithms. The performance of the output improves with the performance of the reference clock. The processing algorithms can also significantly impact the output performance of the timing system. Levels of performance achieved using quartz oscillators, rubidium frequency standards, and cesium-beam frequency standards for the reference oscillator are 10^{-11}, 10^{-12}, and 10^{-13}, respectively. Timing performance with respect to UTC can be better than 100 ns.</p>
<p>Navigation satellite (common-view mode)</p>	<p>For general background information on the GPS and GLONASS systems see the preceding entry in this Table.</p> <p>In the common-view mode of operation with GPS or GLONASS users at two separated sites each receives a signal from the same satellite at the same time. Subtracting the (satellite – local clock) data from the two sites provides the time difference between the local clocks. The advantage is that, in this process, variations or errors in the satellite clock are common to both paths and therefore cancel. If the SA degradation process for GPS is implemented so as to cause variations in the satellite clock, such changes do not affect the common-view measurement accuracy. On the other hand, if SA causes satellite-position errors to be broadcast, such errors will not be totally compensated for in the common-view measurement because each site is receiving the signal over a somewhat different path.</p> <p>The common-view method allows time comparison accuracies of 5 - 20 ns over intercontinental distances, even in the presence of SA (as it is presently implemented in early 1995). Frequency comparisons can be derived from such data to an accuracy of 10^{-13} to 10^{-15}. To facilitate common-view time comparisons among timing laboratories throughout the world the BIPM in Paris generates and distributes suitable common-view tracking schedules showing which satellites are appropriate for this method at various times.</p>	<p>Each site participating in a common-view measurement needs an appropriate GPS or GLONASS receiver and antenna, data-recording capabilities, and a communication link to other participating sites. Accurate receiver location is also required, but this can often be determined automatically by the receiver itself operating in the navigation mode if the position is averaged over a few days.</p> <p>Care must be taken to ensure that the measurements extend over exactly the same time period at each site. The receiver must also be programmed to track the proper satellite that is in common view with the other sites. Typical track lengths are 13 minutes.</p> <p>A subcommittee of the Consultative Committee for the Definition of the Second has recommended standard data formats and other procedural matters to facilitate the use of this method on a regular basis.</p> <p>The technique is usable for baselines between sites of up to 8,000 km.</p> <p>The results from many regular common-view time comparisons among national and international timing centers are published and archived by the BIPM.</p> <p>Receiver-system delays should be calibrated for the highest possible comparison accuracy and the antenna coordinates should be known to within less than 1 meter.</p> <p>The use of multichannel receivers in the common-view mode can provide a convenient frequency-transfer capability at the 10^{-14} level. The potential exists, for example, by using the GPS carrier phase, for extending this performance down to the 10^{-15} region by averaging over days.</p>

Table C2. Additional information relating to the practical use of the various alternative sources of time-and-frequency signals (continued)

System/Technique	Background Information	Comments on equipment and use
Meteorological satellite broadcast	<p>Since 1974 the US Geostationary Operational Environmental Satellite System (GOES) has included a time code referenced to the UTC(NIST) time scale. The time code is disseminated continuously from two geostationary satellites located normally at 75 and 135 degrees West longitude. Satellite position data are also transmitted to users so that suitable automatic receivers can compute the signal path delay and correct their 1-Hz outputs accordingly. Specified time code accuracy as delivered to the user is 100 μs. The normal time code coverage area includes most of the Western hemisphere with overlapping coverage of much of North and South America.</p> <p>The GOES time code includes information on the current year, day of year, hour, minute, second, UT1 correction, system accuracy, and indicators for Daylight-Saving Time and leap seconds.</p>	<p>Commercial receivers with small antennas are available from several manufacturers. Recent versions use the transmitted satellite position information to correct for path delay and update it each 1 minute. Initial setup requires the operator to enter the position coordinates of the receiver location.</p> <p>The GOES time code transmissions are at 2 frequencies near 469 MHz. Because these frequencies are also allocated to the land-mobile service in the US, some interference, particularly near large metropolitan areas, can be expected. Receivers are reasonably effective in "flywheeling" through such periods of interference.</p> <p>In regions of low signal strength or frequency interference use of simple helical or Yagi antennas may improve reception.</p> <p>The received time code typically shows diurnal variations with a peak-to-peak amplitude of 10 - 70 μs due primarily to imperfections in the software used to compute satellite position predictions.</p> <p>The European Meteosat system and the Japanese Geostationary Meteorological Satellite (GMS) system are basically similar to the GOES system but do not currently transmit a time code.</p> <p>GOES satellites suffer time-code signal outages for about 2 hours/day during Spring and Fall eclipse periods each year. Receivers cost about \$5,000 (1997).</p>
Geostationary satellite, multipurpose broadcast	<p>The Indian INSAT geostationary satellites also transmit a UTC-referenced time code as one feature of this multipurpose system. As in the GOES case the time code signal also includes satellite-position information which allows the user to compute and compensate for the signal path delay.</p> <p>The INSAT satellite footprint limits primary coverage to the region of the Indian subcontinent. Within this region the time accuracies of about 20 μs and frequency accuracies of 5×10^{-10} are possible.</p>	<p>Commercial receivers are available (1993) at a cost of about \$4,000. Antenna requirements are modest.</p>
Television broadcast (satellite links)	<p>The measurement technique is the same as reported in the case of terrestrial links, but the signals are received in common view from a direct-broadcast satellite (DBS), extending the coverage area to a nearly continental dimension.</p> <p>The main source of error in the determination of the clock differences arises from the variations in the position of the geostationary satellite used. This drawback can be reduced in different ways, leading to the accuracy ranges reported in Table C-1.</p> <p>It is possible to remove the 12-hour and 24-hour periodic variations by averaging and also, most importantly, to remove the satellite longitude drift observed in the time comparisons with various techniques.</p>	<p>The equipment needed includes a small dish antenna, a commercial satellite TV receiver, and a TV-synchronizing-pulse extractor.</p> <p>A time interval counter at each site measures the time differences between the local clock pulse and the received TV signal from the satellite. Two series of at least 10 such measurements, taken 12 hours apart, are needed daily. A data-acquisition system is also needed for data storage and exchange with the other stations for processing of the results.</p> <p>The correction for satellite-longitude drift which degrades the results can be obtained in several ways: (1) from the satellite position parameters supplied by the satellite-control station; (2) from pseudorange measurements performed by a single station; (3) from GPS satellite measurements performed by at least 3 stations; or (4) from the time measurement performed at 3 ground stations that observe 2 satellites.</p>

Table C2. Additional information relating to the practical use of the various alternative sources of time-and-frequency signals (continued)

System/Technique	Background Information	Comments on equipment and use
Communication satellite (two-way)	<p>At the current time the most precise and accurate method for time comparisons between remote sites is the simultaneous, two-way exchange of timing signals through communication-satellite channels. The high accuracy achievable results from the use of a two-way exchange of signals which effectively eliminates the need for precise knowledge of the satellite's position, the high degree of path reciprocity in the two directions, and the wide bandwidth of the satellite channel which permits efficient signal design.</p> <p>One disadvantage of the technique is the need for each site to both transmit and receive signals and then to exchange the data for post-processing. The earth station equipment at each site tends to be rather expensive, especially if the system is highly automated. Participants in the time transfers must coordinate with each other and with the satellite-system operator.</p> <p>Because of the potential accuracy of near 1 ns and the precision of 0.1 – 0.5 ns, many timing laboratories in various parts of the world are developing a two-way time-transfer capability. Special modems are being developed which are optimized for high accuracy and long-term stability. Suitable satellite channels appear to be available throughout the world at reasonable cost.</p> <p>Frequency transfer is obtained most efficiently by using continuous data. If, for example, one hour's worth of one-second data are taken with a standard deviation of 200 ps, and the data are well modeled by white noise PM, then the frequency transfer uncertainty is only 3.2×10^{-15}.</p>	<p>The earth-station equipment needed at each user site must be compatible with the particular satellites being used for time transfer. Typical costs, including the necessary modems, may reach \$50,000 per site. Operator skills needed for proper operation may be more stringent than for most of the other techniques discussed.</p> <p>Since the two-way technique is essentially a point-to-point communication system, it should not be regarded as a general dissemination technique.</p> <p>As typically implemented, two or more sites exchange timing signals on a regular basis, several times per week. Because of the inherent time stability of the method, it is usually only necessary to perform the exchanges for a few minutes per time. The measurement process involves measuring the difference between the satellite-signal arrival time and the local clock. Such measurements are often made once per second for a period of a few minutes. Subtraction of the simultaneous measurements at each site, divided by 2, provides the difference between the site clocks (except for corrections that may be needed to account for differences in equipment delays).</p> <p>For the highest achievable accuracy of 1 – 10 ns it is important to calibrate the signal delay through the ground-station equipment. This may be a difficult problem since the relevant quantity needed is the difference between the delays through the transmit and receive portions of the system. Several specialized techniques have been developed for this purpose.</p> <p>Depending on the particular satellite system being used and the locations of the stations, extensive administrative procedures may be required in order to certify the earth-station equipment and gain acceptance for satellite access.</p>
Telephone time code (two-way)	<p>A number of timing centers in Europe and N. America have established services designed to disseminate coded UTC time information over telephone lines in an automated mode. Typically, computers or other automated systems are programmed by the user to dial such services as needed, receive an ASCII time code from the timing center, reset the local clock to the correct time, and, in some cases, to automatically compensate for the path delay through the telephone link. Depending on the particular service, the path delay compensation can be performed either by the time center's equipment or at the user's site. The compensation for delay is based on measurements of the round-trip delay time and assumes that the path is reciprocal.</p> <p>Time-transfer accuracies of 1 - 10 ms are possible, even when satellite links may be involved. In addition to the UTC time of day, most services established to date also include information on the year, day of year, UT1 corrections, leap second warnings, and indicators for Daylight-Saving Time.</p>	<p>Equipment requirements to use such services are minimal. Aside from the computer or other equipment containing the clock to be set, only a suitable modem, access to a telephone line, and clock-setting software is needed. In order to perform the path delay compensation the user may also need to be able to echo the received signal back to the timing center.</p> <p>Usually, a telephone connection time of only a fraction of a minute is needed to perform a satisfactory time transfer.</p> <p>Software for using such services is relatively simple to develop by users or some versions of example software are often available via computer bulletin boards, from the timing centers, or from commercial sources at reasonable cost.</p> <p>Most of the available telephone services can also be used on a one-way mode where there is either no compensation for path delay or a fixed, average delay is used. Accuracy for this mode may be in the range of 0.1 to 0.5 seconds.</p> <p>By making periodic measurements of a local clock using one of the telephone services, an average frequency can be determined. Accuracies of about 10^{-8} are possible with 1-day averages. The most efficient frequency transfer accuracies are obtained by staying on-hook.* (See Figure 13.)</p>

* In the case where the measurement noise is limited by white-noise PM, the frequency transfer uncertainty (1σ) is given by $\sqrt{\frac{-3}{12 N^2 \sigma / \tau_0}}$, where N is the number of time difference measurements, σ is the standard deviation of those measurements, and τ_0 is the data spacing.

Table C2. Additional information relating to the practical use of the various alternative sources of time-and-frequency signals (continued)

System/Technique	Background Information	Comments on equipment and use
Optical fiber	<p>Optical fibers offer excellent potential for transferring time-and-frequency signals with very high accuracy over both short (<50 km) and long distances. While dedicated UTC dissemination services using optical-fiber distribution do not currently exist, the technique is included here in recognition of its future potential.</p> <p>Two types of fibers, multimode and single mode, are in use today. Multimode fiber is generally used to transmit digital data and low frequencies over a relatively short distance (e.g., 1 km). Single-mode fiber is best for longer distances (e.g., 50 km) and supports wide bandwidth (e.g., 5 MHz to 100 GHz). Single-mode fiber with a 1,300 nm laser is required to meet the performance given in Table C-1 for local distances.</p> <p>The accuracies stated in Table C-1 for long fiber-optic links have been achieved in a digital telecommunications system adhering to CCITT Recommendations G.707, 708, and 709 over a distance of 2,400 km. This particular system was designed to meet ITU-T requirements as well as to perform time-and-frequency-transfer experiments.</p>	<p>In a practical implementation of a fiber-optic link for time-and-frequency transfer at highest possible accuracy levels, it is important to stabilize the temperature of the cable. The nominal coefficient of delay with respect to temperature is 7 ppm/°C. In order to meet the stated performance in Table C-1 for links longer than 50 km, the cable should be put underground to a depth of at least 1.5 m.</p> <p>For a dedicated optical-fiber link for time-and-frequency transfer, the cost is about \$30,000 per site for transmitters and receivers plus the cost of the cable and its underground installation.</p> <p>Insertion loss is about 0.5 dB/km.</p> <p>Potential users and suppliers of UTC should maintain current awareness of the development of regional, national, and international digital synchronized telecommunication networks. Such networks may provide an excellent, convenient means for distributing high-accuracy UTC time-and-frequency in the future.</p>
Microwave link	<p>The use of microwave links to distribute time-and-frequency within local areas can provide accuracies as high as 1 – 10 ns for timing and 10^{-14} to 10^{-15} for frequency when used in a two-way mode.</p>	<p>Equipment is relatively expensive (\$50,000 - \$75,000).</p> <p>Results are sensitive to atmospheric conditions and multipath effects.</p> <p>For highest accuracy two-way operation is required with a continuously operating feedback loop for nulling out phase delay variations.</p>
Coaxial cable	<p>Coaxial cables offer a convenient means of transferring time-and-frequency information over distances of less than several hundred meters. To achieve the accuracy performance given in Table C-1, careful attention must be paid to temperature environment, temperature stability, and the type and length of cable. Good temperature stability can be achieved by burying the cable at least 1.5 m underground.</p>	<p>Cable cost is about \$5 - \$30 per meter.</p> <p>Insertion loss is dependent on cable length, type and the frequency used.</p> <p>Solid-dielectric cable has a coefficient of delay of 250 ppm (or even greater at 24°C). Air dielectric is 15 ppm, but must be dry-nitrogen pressurized with a dual-stage pressure regulator in an environment controlled to within 1°C.</p>

Glossary and Definitions

Accuracy	Closeness of the agreement between the result of a measurement and a true value of the measurand.
BIPM	International Bureau of Weights and Measures (Bureau International des Poids et Mesures) located in Sevres, France (near Paris). It is the responsible bureau for the basic standards for international commerce and generates the time scales: International Atomic Time (TAI) and Coordinated Universal Time (UTC).
C/A	Clear access channel available for civil usage with GPS receivers. Currently, the time and position information broadcast by GPS on this channel (carrier frequency of 1,575 MHz) is degraded for military security reasons. This degradation is called Selective Availability (SA) and is not to exceed 340 ns (2σ). A U.S. presidential directive guarantees the availability of this channel for civil use on a world-wide basis.
CCDS	Consultative Committee for the Definition of the Second (Comité Consultatif pour la Définition de la Seconde) is comprised of representative atomic-time experts from the nations of the world — acting in an advisory capacity to the International Committee of Weights and Measures (CIPM), which in turn provides input to the CGPM.
CGPM	General Conference of Weights and Measures (Conférence Générale des Poids et Mesures) is organized under the 1875 <i>la Convention du Mètre</i> . Each signatory nation has membership. The CGPM is the final voice for the International System (SI) of units that provide the base standards (ampere, candela, kelvin, kilogram, meter, mole, and the second) for world commerce.
CIPM	International Committee of Weights and Measures (Comité International des Poids et Mesures) receives input from the sundry consultative committees, such as the CCDS, and submits input to the CGPM for final approval of international standards under agreement of the <i>la Convention du Mètre</i> .
Ephemeris	A table giving the coordinates of a celestial body at a number of specific times within a specific period.
Error	Result of a measurement minus a true value.

Frequency Instability	The frequency change, typically averaged for an interval, τ , with respect to another frequency. Generally one distinguishes between frequency drift effects and stochastic frequency fluctuations. Special variances have been developed for the characterization of these fluctuations.
GLONASS	The Russian Federation's Global Orbiting Navigation Satellite System (GLONASS: GLObal Orbiting Navigation Satellite System). It features 24 satellites in three orbital planes inclined 64.8° to the equatorial plane. The GLONASS satellites transmit the same code but at different frequencies. Both the U.S. GPS and GLONASS are operated by their respective defense departments and offer precise, global and continuous position-fixing capabilities.
GMT	Greenwich Mean Time is time as kept at the zero meridian — often referred to as zulu time (referring to the z time zone). It was the official name for world time until 1972.
GNSS	The Global Navigation Satellite System — a major international coordinated initiative to provide a seamless global navigation and positioning system by satellite.
GPS	The U.S. Department of Defense's Global Positioning System. It features 24 satellites in six orbital planes inclined 55° to the equatorial plane. The GPS satellites transmit at the same carrier frequency using codes that are orthogonal. The very accurate atomic clocks on board the satellites allow worldwide navigation, positioning and timing.
IEEE	The Institute of Electrical and Electronics Engineers, Inc.
IERS	International Earth Rotation Service provides a coordinated set of measurements of the earth's angular position with respect to the celestial sphere and International Atomic Time. It is headquartered at the Paris Observatory with primary input from the United States Naval Observatory along with numerous other observatories and radio telescopes around the world.
INMARSAT	International Maritime Satellite Organization.
ITU	International Telecommunication Union located in Geneva, Switzerland.

Mean Solar Day	A division of time equal to 24 hours and representing the average length of the period during which the earth makes one revolution on its axis with respect to the sun.
Metrology	The science of, or a system of, weights and measures.
MTSAT	Japan's Multi-functional Transport Satellite
Precision	Random uncertainty of a measured value, expressed by the standard deviation or by a multiple of the standard deviation.
SA	Selective Availability is an intentional degradation of the GPS signal for civil users. This is intended to protect high accuracy usage by the military. The guaranteed accuracy of GPS positioning and timing when receiving the C/A signal is 100 meters and 340 nanoseconds, respectively with a 95 percent confidence interval.
SI	International System of Units (Systemè International d'Unites)(see CGPM).
Synchronization	The times of clocks are in synchronization if their readings are the same after accounting for reference frame delays and relativistic effects. Synchronization needs to be specified to within some level of uncertainty.
Syntonization	The rates or frequencies of clocks are in syntonization if the rates are the same after accounting for reference frame corrections and relativistic effects. Syntonization needs to be specified to within some level of uncertainty.
Uncertainty	Parameter associated with the result of a measurement that characterizes the dispersion of the values that could reasonably be attributed to the measurand. Frequently, it is possible to distinguish two components: Type A described by statistical analysis of a series of observations, and Type B, those not described as in Type A. These are often referred to as the random and systematic components, but need not be. See reference [32] for details.
UT?	UT0, UT1, UT2 and UTC are a family of Universal Time scales. The first three are derived from Earth spin and orbit dynamics (see second paragraph in "Historical Perspective" and reference [8] for more details). The last one is official world time as explained throughout the text.

Bibliography

1. B. Guinot, 1989, *Atomic time scales for pulsar studies and other demanding applications*, *Astronomy & Astrophysics*, 192, pp. 370-373.
2. D.W. Allan, *Millisecond Pulsar Rivals Best Atomic Clock Stability*, Proceedings of the 41st Annual Symposium on Frequency Control, Philadelphia, PA, 2-11, 1987.
3. R.L. Walsworth, E.M. Mattison, E.R. Oteiza, R.E. Stoner, K.Y.N. Tan, R.F.C. Vessot, and I.A. Yu, *Precision Measurements with new Hydrogen, Rubidium, and Noble Gas Masers*, Proc. Fifth Symposium on Frequency Standards and Metrology, 1995, World Scientific, pp 187-201, edited by James C. Bergquist.
4. J.R. Vig, *Quartz Crystal Resonators and Oscillators for Frequency Control and Timing Applications, A Tutorial*, Available from John R. Vig, Army research Laboratory, Fort Monmouth, NJ 07703-5601, USA, or e-mail: j.vig@ieee.org. November 1996.
5. D.W. Allan, J.E. Gray, and H.E. Machlan, *The National Bureau of Standards Atomic Time Scale: Generation, Stability, Accuracy and Accessibility*, NBS Monograph 140, Time and Frequency: Theory and Fundamentals, 205-231, 1974.
6. A. Clairon, S. Ghezali, G. Santarelli, Ph. Laurent, E. Simon, S. Lea, M. Bahoura, S. Weyers and K. Szymaniec, *The LPTF Preliminary Accuracy Evaluation of Cesium Fountain Frequency Standard*, Proceedings of Tenth European Frequency and Time Forum, (1996) Brighton, UK, pp. 218-223.
7. Wm. Markowitz, R. G. Hall, L. Essen and J. V. L. Parry, 1958, *Frequency of Cesium in Terms of Ephemeris Time*, *Phys. Rev. Let.*, vol. 1, pp. 105-106.5.
8. D.D. McCarthy, 1991, *Astronomical Time*, Proceedings of the IEEE, Vol. 79, No. 7, pp. 915-920.
9. C. Thomas, and J. Azoubib, *Metrologia*, 1996, 33, pp 227-240.
10. P. Tavella, and C. Thomas, *Metrologia*, 1991, 28, pp 57-63.
11. C. Thomas, *Stability and Accuracy of UTC and TAI, and Impact of New Clock Technology*, Proc. 50th 1996 IEEE International Frequency Control Symposium, pp 1123-1130.
12. D. Bodson, R.T. Adair, M.D. Meister, *Time and Frequency Information in Telecommunications Systems Standardized by Federal Standard, 1002A*, Proc. IEEE 79, No. 7, July 1991, pp 1077-1079.

13. D.W. Allan, D.D. Davis, M. Weiss, A. Clements, B. Guinot, M. Granveaud, K. Dorenwendt, B. Fischer, P. Hetzel, S. Aoki, M.-K. Fujimoto, L. Charron, and N. Ashby, *Accuracy of International Time and Frequency Comparisons Via Global Positioning System Satellites in Common-View*, IEEE Transactions on Instrumentation and Measurement, IM-34, No. 2, 118-125, 1985.
14. J.D. Crum, *1996 GPS Time Transfer Performance*, Proc. 1996 Precise Time and Time Interval Planning and Applications Meeting.
15. D.W. Allan, and W. Dewey, *Time-Domain Spectrum of GPS SA*, Proceedings of 1993 ION GPS Sixth International Technical Meeting, Sept. 1993 held in Salt Lake City, Utah.
16. See Annual Report of the BIPM Time Section for Specific Calibration Values of TAI by the different primary frequency standards, Vol. 9, 1996.
17. W. M. Itano, L. L. Lewis, and D. J. Wineland, Phys. Rev. A25, 1233, (1982).
18. Eric Simon, P. Laurent, C. Mandache and A. Clairon, *Experimental measurement of the shifts of Cs $6^2 S_{1/2}$ hyperfine splittings due to the D.C. electric field and black body radiation*, Session 3: Cesium Standards, Paper 1, 11th European Frequency and Time Forum, Neuchâtel, Switzerland, 4-6 March 1997.
19. Rolf Augustin, A. Bauch and R. Schröder, *Shift of the caesium hyperfine transition frequency due to black-body radiation: first experimental verification*, Session 3: Cesium Standards, Paper 2, 11th European Frequency and Time Forum, Neuchâtel, Switzerland, 4-6 March 1997.
20. N. Ashby and D.W. Allan, *Practical Implications of Relativity for a Global Coordinate Time Scale*, Radio Science, 14, No. 4, 649-669, 1979.
21. N. Ashby and M. Weiss, *GPS Receivers and Relativity*, NIST Technical Note 1385, (to be published).
22. Robert F. C. Vessot, M. W. Levine, E. M. Mattison, E. L. Blomberg, T. E. Hoffman, G. U. Nystrom, B. F. Farrel, R. Decher, P. B. Eby, C. R. Baugher, J. W. Watts, D. L. Teuber and F. D. Wills, *Test of relativistic gravitation with a space-borne hydrogen maser*, Physical Review Letters 45, 2081-2084, 1980.
23. N. Ashby, *Planetary Perturbation Equations Based on Relativistic Keplerian Motion, in Relativity in Celestial Mechanics and Astrometry*, eds. J. Kovalevsky and V. A. Brumberg, Proc. of IAU Symposium No. 114, Leningrad, May 28-31, 1985, (D. Reidel, Dordrecht, 1986), pp 41-52.

24. G. Petit, P. Wolf, *Relativistic Theory for Picosecond Time Transfer in the Vicinity of the Earth*, Astronomy and Astrophysics, 1994, 286, pp. 971-977.
25. P. Fridelance, E. Samain and C. Veillet, *T2L2: Time transfer by laser link: a new optical time transfer generation*, accepted for publication in Experimental Astronomy, January 1997.
26. Clifford C. Hodge, John A. Davis, John C. Gallop, David W. Allan, Neil Ashby, Stefan Bedrich, Leonard S. Cutler, Jörg Hahn, Hartmut Nau, Robert H. Kern, Wlodzimierz Lewandowski, Lutfollah Maleki and Robert F. C. Vessot, *Towards 10 millimetre real-time position determination and 30 picosecond time-transfer capability with the next-generation of global navigation satellite systems (GNSS)*, Proc. ION GPS-96, Session D1: GNSS and WAAS Architectures, Paper 3, pp. 1127-1142, Kansas City, Missouri, United States of America, September 17-20, 1996.
27. See the Proceedings of Institute of Navigation, GPS International Technical Meetings held annually for several papers on the status, accuracy and plans for WAAS program. Contact Satellite Division of ION for copies of proceedings.
28. Wlodzimierz Lewandowski, J. Azoubib, M. Weiss, V. Zhang, V. Hanns, A. Gevorkyan, P. Bogdanov, N. Tutolmin, J. Danaher, G. de Jong, J. Hahn, M. Miranian, *GLONASS time transfer and its comparison with GPS*, Session 8: Time and Frequency Comparisons, Paper 1, 11th European Frequency and Time Forum, Neuchâtel, Switzerland, 4-6 March 1997.
29. B. Tiemeyer, A. Watt and R. Farnworth, *Can GNSS be certified for civil aviation?*, Proc. ION GPS-96 Session E1: GPS, GLONASS and GNSS Policy Issues, Paper 3, pp. 1483- 1491, Kansas City, Missouri, United States of America, September 17-20, 1996.
30. L. Marton (ed.) (1977) Advances in Electronics and Electron Physics. Volume 44, Chapter 2, *Timekeeping and its Applications*, by Gernot M.R. Winkler, p.33-97. Academic Press.
31. *Time and Frequency Measurement*, edited by Christine Hackmand and Donald B. Sullivan, American Association of Physics Teachers.
32. Guide to the Expression of Uncertainty in Measurement, 1993, BIPM, IEC, IFCC, ISO, IUPAC, IUPAP, OIML.
33. D.B. Sullivan, D.W. Allan, D.A. Howe, and F.L. Walls, *Characterization of Clocks and Oscillators*, NIST Tech Note 1337, 1990.

34. IEEE Standard 1139-1988, *Standard Terminology for Fundamental Frequency and Time Metrology*, available from Secretary, IEEE Standards Board, 445 Hoes Lane, P.O. Box 1331, Piscataway, NJ 08855-1331, USA.
35. IEEE Standard 1193-1994, *IEEE Guide for Measurement of Environmental Sensitivities of Standard Frequency Generators*, available from Secretary, IEEE Standards Board, 445 Hoes Lane, P.O. Box 1331, Piscataway, NJ 08855-1331, USA.
36. D. W. Allan, M. A. Weiss, J. L. Jespersen, *A Frequency-Domain View of Time-Domain Characterization of Clocks and Time and Frequency Distribution Systems*, Proceedings of the Forty-Fifth Annual Symposium on Frequency Control, pp. 667-678, 29-31 May 1991.
37. Woodward, Phillip, *My Own Right Time*, ISBN 0-19-856522-4.
38. Sobel, Dava, *Longitude*, ISBN 0-14-025879-5.
39. Betts, Jonathan, *John Harrison*, published by the U.K. National Maritime Museum, 1993.
40. Frequency Stability Analysis by STABLE: Hamilton Technical Services, 195 Woodbury Street, S. Hamilton, MA 01982, USA, (508) 468-3703.
41. D. Howe, *An Extension of the Allan Variance with Increased Confidence at Long Term*, Proc. 1995 IEEE international Frequency Control Symposium, 95CH3446-2, 445 Hoes Lane, Piscataway, NJ, 08854, pp. 321-329.
42. D.W. Allan, *Should the Classical Variance Be Used as a Basic Measure in Standards Metrology?*, IEEE Trans. on Instrumentation and Measurement, IM-36, 646-654, 1987.

For more information:

Designing Your GPS Antenna System — Configuration Guide

Application Note 1272: GPS and Precision Timing Applications

For more information about Hewlett-Packard test and measurement products, applications, services and for a current sales office listing, visit our web site, <http://www.hp.com/go/tmdir>. You can also contact one of the following centers and ask for a test and measurement sales representative.

United States:

Hewlett-Packard Company
Test and Measurement Call Center
P.O. Box 4026
Englewood, CO 80155-4026
1 800 452 4844

Canada:

Hewlett-Packard Canada Ltd.
5150 Spectrum Way
Mississauga, Ontario
L4W 5G1
(905) 206-4725

Europe:

Hewlett-Packard
European Marketing Centre
P.O. Box 999
1180 AZ Amstelveen
The Netherlands
(21 20) 547 9900

Japan:

Hewlett-Packard Japan Ltd.
Measurement Assistance Center
9-1, Takakura-Cho, Hachioji-Shi,
Tokyo 192, Japan
Tel: (81-426) 56-7832
Fax: (81-426) 56-7840

Latin America:

Hewlett-Packard
Latin American Region Headquarters
5200 Blue Lagoon Drive
9th Floor
Miami, Florida 33126
U.S.A.
(305) 267 4245/4220

Australia/New Zealand:

Hewlett-Packard Australia Ltd.
31-41 Joseph Street
Blackburn, Victoria 3130
Australia
1 800 629 485

Asia Pacific:

Hewlett-Packard Asia Pacific Ltd.
17-21/F Shell Tower, Time Square,
1 Matheson Street, Causeway Bay,
Hong Kong
Tel: (852) 2599 7777
Fax: (852) 2506 9285

**Data Subject to Change
Printed in U.S.A. June 1997**

**Hewlett-Packard Company
Copyright © 1997
5965-7984E**